

INTERNATIONAL  
TECHNOLOGY ROADMAP  
FOR  
SEMICONDUCTORS 2.0

2015 EDITION

OUTSIDE SYSTEM CONNECTIVITY

THE ITRS IS DEvised AND INTENDED FOR TECHNOLOGY ASSESSMENT ONLY AND IS WITHOUT REGARD TO ANY COMMERCIAL CONSIDERATIONS PERTAINING TO INDIVIDUAL PRODUCTS OR EQUIPMENT.

CERTAIN COMMERCIAL EQUIPMENT, INSTRUMENTS, OR MATERIALS ARE IDENTIFIED IN THIS CHAPTER IN ORDER TO SPECIFY THE EXPERIMENTAL PROCEDURE ADEQUATELY. SUCH IDENTIFICATION IS NOT INTENDED TO IMPLY RECOMMENDATION OR ENDORSEMENT BY THE NATIONAL INSTITUTE OF STANDARDS AND TECHNOLOGY AND ITRS, NOR IS IT INTENDED TO IMPLY THAT THE MATERIALS OR EQUIPMENT IDENTIFIED ARE NECESSARILY THE BEST AVAILABLE FOR THE PURPOSE.

## 1. TABLE OF CONTENTS

Outside System Connectivity.....	1
6.1. Introduction.....	15
6.2. Technology Requirements.....	15
6.2.1 RF CMOS .....	15
6.2.2. Group IV Bipolar .....	16
6.2.3. Group III-V Compound Semiconductors consisting of elements from groups III and V [both bipolar and field effect transistors (FET)].....	18
6.3. RF & AMS Difficult Challenges.....	21
6.4. Potential Solutions.....	22
6.4.3. Group III-V Compound semiconductors consisting of elements from groups III and V [both bipolar and field effect transistors (FET)].....	23

## 2. LIST OF FIGURES

Figure OSC2 Analog and Carrier Frequency Bands and Example Applications considered in formulating this Roadmap.....	5
Figure OSC20. Group III-V Compound Semiconductors Potential Solutions.....	23

## 3. LIST OF TABLES

Table OSC12 Group III-V Compound Semiconductor FET and Bipolar Transistors Technology Requirements .....	21
--	----

# OUTSIDE SYSTEM CONNECTIVITY

---

## 1. MISSION

Identify and assess capabilities needed to connect most elements of the internet of everything (IoE) and highlight technology needs and gaps. This includes supporting connection of a broad range of sensors, devices, and products and to support information communication, processing and analysis for many applications (i.e. mobility, energy, health, and others) with wireline, wireless and optical interconnect technologies.

## 2. SCOPE

Outside System Connectivity encompasses the assessment of future products and devices in the Internet of Things (IOT) which are mobile and need to be connected to the internet, the devices required to communicate with the internet and communication technologies required to deliver information to the cloud and analyze the dispersed big data that is generated. Specifically, for mobile devices, this includes devices to enable CMOS and III-V circuits, passives, and antennas and for high bandwidth fixed systems this includes devices to driver circuits for optical emitters and modulators, lasers, LEDs, optical couplers, optical modulators, multiplexers and de-multiplexers, detectors, amplifiers and signal conditioners.

Examples of IOT devices could include embedded medical devices, appliances, autonomous vehicles, tools, energy monitoring devices, etc. Many of these devices will communicate with the internet through wireless RF and may need to connect though multiple types of systems, such as WiFi™, Blue Tooth™, wireless phone protocols, etc. For many devices such as implanted medical devices, autonomous vehicles, energy regulating devices, etc., security from tampering will be critical, so both software and hardware solutions may be required to provide adequate security from wireless intruders or internet hacking. Thus, a wide range of wireless solutions may be required, so the RF scope includes devices to enable CMOS and III-V circuits, passives, and antennas.

The second area is the evaluation of components to support higher bandwidth, low power optical interconnects required to face the foreseeable dramatic increases in information communication and access. With increasing internet traffic volumes, The Cloud, Big Data, etc., bandwidth of communication across the internet, within server farms, and eventually within multi-processor servers will need to dramatically increase. While multiple modes of communication may be used to support these needs, the trend will be for optical communication to increase bandwidth, increase energy efficiency, and be used for shorter distance communication over time. Currently, information is transferred over the internet in small “packets” that don’t necessarily follow the same route; however, there are proposals to have dedicated connections (these dedicated connections are often called “circuits” as these connections were called in the old, hard wired, relay switched telephone days) between server farms and within server farms. There are also proposals to have an internet that has a combination of “packet” and dedicated connections (circuits). To enable energy efficient, cost effective transfer of “Big Data”, future optical networks may utilize optical switching and potentially routing to avoid O to E to O conversions and the associated energy and latency penalties. Thus, as the future internet is defined, new devices and materials may be needed to support this functionality. Free space optical communication is emerging as a potential application in warehouses to manage inventory as well as data centers to provide greater flexibility via software defined directional transmission and reception.

## 2 Outside System Connectivity

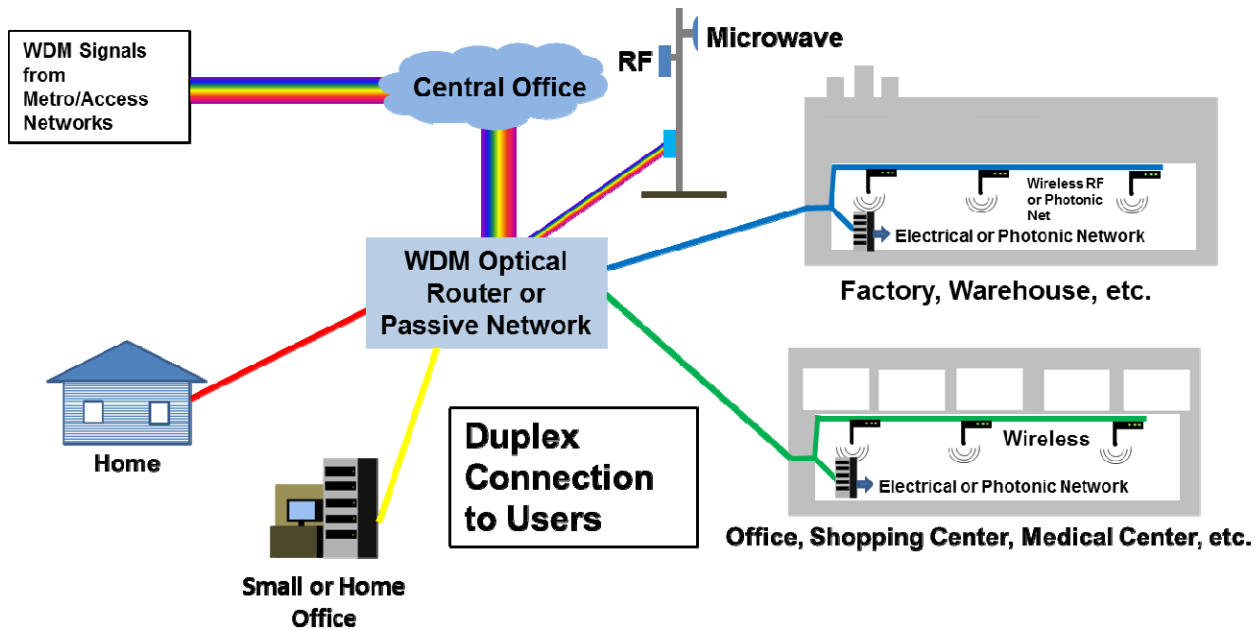

Figure OSC1. Wireless and Optical Interconnect Networks Example

Figure OSC1. An example of a network from the “Cloud” to large offices, small offices and homes where electrical, optical and wireless communication are employed to support different needs.

Finally, while this does not address them specifically, technologies supporting electrical signal transmission over wires are expected to continue to evolve. This could include novel copper interconnect materials with low dispersion and losses.

The scope of Outside System Connectivity is extremely large, so the 2015 version of this chapter will only address a limited set of capabilities and applications. This scope will be expanded in future versions of the chapter.

## 3. DIFFICULT TECHNICAL CHALLENGES

RF and Optical Interconnects each have different challenges, as shown in Table OCS1, so these will be discussed separately.

Table OSC1: Outside System Connectivity Difficult Challenges

Difficult Challenges 2015-2022	Summary of Issues
Achieving high performance energy efficient RF analog technology compatible with CMOS processing	<p>Achieving high performance RF required reduced gate resistance which is difficult to achieve</p> <p>Integrating SiGe with CMOS is difficult to achieve high performance heterojunction bipolar transistors (HBT)</p> <p>Integrating III-Vs with CMOS it is difficult to achieve high performance III-V devices</p> <p>Increasing passive device functional density on chip; e.g., resistors, inductors, varactors, and capacitors</p>
Deliver wireless capabilities to support a broad range of applications for IoT devices	<p>Increasing antenna complexity to support multiple applications</p> <p>Security: While solutions to avoid tampering / intercept of RF communications will probably mainly rely on software solutions, and hardware technologies beyond the scope of the Outside System Connectivity Focus Team (e.g., cryptography), we cannot exclude the possibility that security concerns will have an impact on RF technology requirements</p>
Reducing cost of Optical Interconnects	<p>Reducing the large number of components (hundreds) that are expensive</p> <p>Reducing the cost of single mode connected optical devices</p> <p>Increasing optical interconnect density while reducing cost and power</p>

	<p>Reducing optical device power</p> <p>Increasing Density of MUX/DeMUX and reducing the size of this functionality.</p> <p>Developing low cost joining methods to provide the sub-micron location tolerances needed over the life cycle of single mode structures.</p>
<i>Increase the bandwidth density (bits/mm<sup>2</sup>) of Optical Interconnects</i>	<p>Increasing the density of DeMUX with multiple wavelengths, polarizations, etc.</p> <p>Increasing the operating frequency of modulators while reducing power consumption</p> <p>Increasing the operating frequency of detectors while reducing power</p> <p>Simultaneously fabricating and joining multiple parallel fibers or waveguides</p>
<i>Improve the reliability of optical Interconnects</i>	<p>Determine factors that limit the reliability of lasers for single mode OI</p> <p>Improve the reliability of connector technology</p> <p>Determine factors that limit the reliability of modulators, MUXes, DeMuxes</p>
<b>Difficult Challenges 2023-2030</b>	<b>Summary of Issues</b>
<i>Agreeing on Optical technology standards</i>	By 2023, multiple optical implementations are likely to be in use implying that standardization could result in cost saving. Will standards emerge or will multiple proprietary solutions prevail?
<i>Processing information in the optical domain</i>	<p>Regenerate digital signals in the optical domain without returning to the electronic domain, a capability that is likely to require non-linear optical materials.</p> <p>Perform logic operations in the optical domain</p> <p>Switch optical streams (circuit switching) in the optical domain.</p>
<i>Establish a System Level Reliability Strategy</i>	<p>Identify a strategy for reliable O/I with point to point connectivity</p> <p>Identify a strategy for reliable O/I with LAN connectivity</p>
<i>Utilize the "Z" dimension more effectively</i>	Optical devices are often linear or planar yet much could be done, especially to reduce size, utilizing the 3 rd. dimension. Design, but specially fabrication in "Z" is "hard". Some type of 3D printing might enable this technical solution.

### 3.1. RF KEY TECHNICAL CHALLENGES

In the near term, the key challenges for RF are to achieving high performance energy efficient RF analog technology compatible with CMOS processing and delivering capabilities to support a broad range of applications for IoT devices, as shown in Table OSC1. To achieve high performance RF with high energy efficiency, CMOS gate resistance must be reduced with technologies that are compatible with CMOS processing. Furthermore, SiGe and III-V performance needs increased  $f_t$  and  $f_{max}$  while being integrated with CMOS. Furthermore, passive devices need to be integrated on CMOS with higher performance.

To support a wide range of internet of everything (IoT) devices, increasingly complex antenna need to be developed that can fit in small form factor systems. Also, security capabilities need to be developed to eliminate hacking or eavesdropping by unauthorized devices.

### 3.2. OPTICAL INTERCONNECT KEY TECHNICAL CHALLENGES

Many applications would make use of optical interconnects to increase data rates and reduce energy consumption; however, significant challenges must be overcome for these to be viable. In the near term, it is critical that the cost of optical interconnect technologies be reduced and also that the information density be increased, as shown in Table OSC1. The most immediate need to exploit optical technology for connectivity is to reduce cost for emerging applications. The known current and potential applications are:

1. Data transmission for < 5km fiber to the home, <10 meters in data centers, <1 meter in racks, a few centimeters device to device.
2. High end microprocessors requiring > 10Tb/s of data IO
3. Potentially sensors of molecules, biological agents and images

## 4 Outside System Connectivity

Reducing the cost of optical technologies for these applications requires design, process development and component integration to minimize acquiring components and joining/assembling these individual parts. Thus achieving lower cost requires defining the details of the application needs so that specific processes can be developed and improved.

In the longer term, standard interfaces will need to be developed for a number of high performance optical interconnect technologies. To eliminate multiple optical-electrical-optical conversions in routing signals, optical information processing and logic needs to be developed. To increase optical processing density the third dimension needs to be utilized, as shown in Table OSC1.

The longer term challenge that needs the most research is to enable optical logic and routing functions. As mentioned earlier, significant time and energy is expended in converting optical signals to electrical signals in a router, decoding them to set the path and then converted to optical signals that are launched on the new path. If it were possible for optical logic to decode the routing instructions and change the optical path, this could significantly reduce the latency and potentially the energy of optical routing in a data center or local area network. Research is needed to identify materials, structures and devices that could perform logic such as decoding instructions, identifying paths that are available and switching the optical data stream to a new path.

## 4. INTRODUCTION

### 4.1. RF & AMS INTRODUCTION

Radio frequency (RF), high frequency (HF), and analog/mixed-signal (AMS) technologies serve the rapidly growing communications markets that include many of the physical components for the Internet of Everything (IoE) (e.g., <http://www.cisco.com/web/about/ac79/innov/IoE.html>) and represent essential and critical technologies for the success of many semiconductor manufacturers. Communications products and emerging products with functionalities enabled by more-than-Moore (MtM) RF, HF, and AMS technologies are becoming key drivers for volume manufacturing. Consumer products account for over half of the demand for semiconductors. Fourth generation (4G) cellular phones and tablets now have a much higher RF and AMS semiconductor content and now are a very large fraction of the mobile market compared to only 5 % of the market a few years ago. The 4G Apple iPad for example has more than 19 RF and AMS front-end components. The consumer portions of the RF and AMS markets are very sensitive to cost. With different technologies capable of meeting technical requirements, time to market and overall system cost will govern technology selection.

The IoE has four main components that connect physical things; data, processes, and people:

1. The Internet of Things (IoT) is the global network of physical objects accessed through the Internet and incorporates the infrastructure for the internet-connected world of devices-objects-things. The IoT includes the following ITRS 2.0 application areas: mobile products, big data systems, the Cloud 2.0, biomedical products, transportation components and subsystems and interconnect.
2. Data that are generated by all of the devices-objects-things in item 1 above.
3. Smart applications for processing in a timely manner the data generated by the IoT to deliver the right information to the right machine or person at the correct time and thereby for solving problems (societal, economic, environmental, and the like) for industry and governments.
4. Application software/programming interfaces that connect people in more relevant and valuable ways.

RF and AMS technologies, both wireless and tethered, are the critical enablers for the IoT.

As compared with the scope of the 2013 RF and AMS International Technology Roadmap for Semiconductors (ITRS), the scope for the 2016 Outside System Connectivity Charter is expanded to include both wireless and tethered technologies based on:

1. RF Complementary Metal Oxides Semiconductor (CMOS)
2. Group IV Silicon Bipolar and BiCMOS
3. mm-Wave Groups IV and III-V Compound Semiconductors

The requirements for transceiver integrated circuits (ICs) are technology drivers that contribute substantially to the recent ITRS-defined More-than-Moore (MtM) thrust. This 2016 ITRS RF and AMS Section is divided into the four analog-carrier frequency bands – low frequency (LF) less than 0.4 GHz, radio frequency (RF) 0.4 GHz to 30 GHz, millimeter-

wave (mm-wave) 30 GHz to 300 GHz, and terahertz (THz) greater than 300 GHz. Figure OSC2 lists a few examples of applications for each of these bands.

<b>Analog - Carrier Frequency Bands</b>			
<b>LF Analog (0.0 GHz-0.4 GHz)</b>	<b>RF (0.4 GHz-30 GHz)</b>	<b>Millimeter-Wave (30 GHz-300 GHz)</b>	<b>THz (&gt; 300 GHz)</b>
<b>Example Applications for Each Frequency Band</b>			
Automotive controls	Cellular	60 GHz point-to-point	
On-chip regulators	WLAN	Touchless gesture control, Imaging, sensing	
Power management	Serializer/ Deserializer	Automotive radar	
	ADC, DAC	Wireless backhaul	

*Figure OSC2 Analog and Carrier Frequency Bands and Example Applications considered in formulating this Roadmap*

Strictly speaking, RF covers, as shown in Figure OSC2, the 0.4 GHz to 30 GHz frequency range.

Some portions of the RF and AMS technologies roadmap pertain more to prototype capabilities rather than usual (digital) CMOS volume production of most of the other ITRS Chapters. Production implies applications and markets, but also, emerging mm-wave connectivity, especially for the IoT. The IoT-enabled applications listed above are part of the scope for the RF and AMS ITWG and currently lag technology and processing capabilities for reliable manufacturing similar to digital CMOS.

Figures of merit (FoMs) for device technologies that relate to those circuit-level FoMs needed to support the performance requirements of systems drive the RF -AMS roadmap. The FoMs included in the RF and AMS roadmap are those for low-noise amplifiers (LNA), voltage-controlled oscillators (VCO), and power amplifiers (PA).

#### **4.2. OPTICAL INTERCONNECTS INTRODUCTION**

Information processing systems are physically limited by both energy dissipation and communication of information, especially in dense, high-speed systems. Overall, the majority of energy dissipation in systems is in the interconnection and communication. Optics offers solutions to both of these problems, enabling lower energy communication and higher densities, especially for all longer distances beyond the chip itself. The two main advantages of optics are:

1. Low power loss over distance. Attenuation of single mode optical signals is < 0.3db/Km over hundreds of Km.
2. Very high information density. A single mode 0.125 mm diameter optical fiber can transmit information >100 Exabits/s/mm<sup>2</sup>. (A bandwidth of ~200Terahertz, spectral efficiency of 10 bits/Hz and a fiber diameter of 125 microns.)

In addition, in the future, optical technology could offer new possibilities for information processing at low or even essentially zero power; however, significant research would be needed for materials and devices with optical amplification and logic functions.

## 6 Outside System Connectivity

The components for optical interconnects depend on whether the technology is based on direct modulation of the laser or indirect modulation as shown in Table OSC2. In telecommunication systems, multiple wavelengths, modulation of intensity of the light, polarization, and higher order modulation of the light are employed to increase information density in a fiber. For telecommunication systems, the size of the components, energy consumption and cost are not critical factors; however, for other applications size and energy consumption are very important. To meet future roadmap requirements of performance (bandwidth and bit error rate), energy dissipation, and total cost, significant progress must be made in integrating components, increasing information density, and reducing component energy consumption. As the data rates increase, more wavelengths and modulation techniques may be employed to support increases in information density, as shown in Table OSC3.

Table OSC2 Optical Interconnect Building Blocks

Table OSC3 WDM Module Performance

## 5. APPLICATIONS

The applications for outside system connectivity include mobile smart phones, mobile medical devices, IoT devices, office and factory local area networks (LAN), data centers, telecommunications, final link of telecommunications (FTTX), automotive, and aerospace. Each of these applications has different requirements for data rates, data densities, energy consumption, and other environmental factors. Each of these will be discussed with the requirements for RF and optical interconnects and potential solutions to the requirements.

### 5.1. MOBILE SMART PHONES

As smart phones add more functionality, they will need to communicate at higher data rates with the internet, but also detect signals from GPS, cell towers, health monitors, watches, and other RF sources. Thus, they will need to have compact antennas that can receive and transmit to multiple ranges of frequencies with multiple protocols. The RF & AMS components will need to support all of the communication with high energy efficiency for multiple applications simultaneously.

A critical need for these devices is technology that enables highly secure operation and communication with the internet and other devices.

Also, with the increasing proliferation of wireless devices, there are significant concerns that interference between electrical and wireless devices will become a huge problem in the future. Some are proposing development of novel antenna and other schemes.

### 5.2. MOBILE MEDICAL DEVICES

Embedded (in patient) medical devices must be highly secure, consume low amounts of energy, and be highly reliable. They will need to communicate over RF with the internet, or with other devices in the future, such as autonomous vehicles to identify a medical emergency. On the other hand, they must not allow unauthorized access to the device that could jeopardize the patient, such as defibrillators activating pulses or withholding or overdosing insulin. These devices may have secure frequencies for program changes and other frequencies for transmittal of data or emergency assistance requests. These devices should be able to use capabilities developed for other applications.

### 5.3. MISCELLANEOUS IOT DEVICES

IoT devices cover a wide range of products that need to communicate with the manufacturer or owner through their life. The most pervasive communication method will be through RF protocols. These devices would include appliances, tools, manufacturing equipment, and a wide variety of devices that include electronic control systems. They would connect to the internet through available network connections such as WiFi, Bluetooth, etc. The need to communicate with the internet could include identifying a lack of activity by an elderly relative or detecting unexpected intrusions into a home. Again, security systems at the device level and in the internet are critical to prohibit unwanted monitoring of activity or malicious activation by hackers or vandals.

Also, with the increasing proliferation of wireless devices, there are significant concerns that interference between electrical and wireless devices will become a huge problem in the future. Some are proposing development of novel antenna and other schemes.

### 5.4. OFFICE AND FACTORY LOCAL AREA NETWORKS

Scope: This includes large offices, hospitals, factories, warehouses, and very large stores.



Offices and factories will have ever increasing need for bandwidth as more information is being transmitted by the internet of things and analyzed to improve business performance. Offices will require conventional services including messaging, and access to data from the “cloud” to analyze customer requirements, product availability, product performance (IoT) reports, etc. This will require increasing bandwidth over time which will require a combination of optical and wireless communications technologies, as shown in Figure OSC1. In factories, information will be communicated between the tools in the manufacturing flow and manufacturing control where performance of individual tools will be monitored and issues “flagged”. This will require a local area network with connection to individual manufacturing tools, manufacturing control, technicians and engineers. The network should include a high bandwidth optical interconnect “back bone” connected to manufacturing control, fixed tools, and engineering analysis stations. Wireless connection could be used for communication with low data rate manufacturing tools and material handling systems that are mobile. The configuration of optical and wireless communication technologies will depend on the requirements of the office, factory, or warehouse. Optical interconnect technologies to be used could include high bandwidth fiber and/or a free space optical interconnect system (LiFi) with a wide range of wireless technologies including WiFi, Bluetooth, custom wireless, and new wireless systems.

Medical facilities, such as hospitals, may have some tools or operating room areas that are sensitive to RF and EMI, so they may limit communication to shielded wire or optical interconnects for connectivity.

Since many technologies may be required to support these applications, only the optical interconnect LAN requirements will be discussed in detail in this section and others will be discussed in separate sections.

#### 5.4.1. OPTICAL INTERCONNECT LAN

The optical interconnect LAN requirement is projected to increase from current data rates of 40Gb/s-wavelength with four wavelengths to 2000Gb/s-wavelength with 8 wavelengths as shown in *Table OSC4*. Over this time, the power dissipation/Gbs will need to decrease by over a factor of four. To achieve these high data rates for each wavelength new technologies are required to compress more information in a single wavelength.

The biggest challenges for fiber optical LAN are to 1) increase data rates while reducing energy/bit and 2) reduce latency due to optical-electrical-optical conversion, as shown in Table OSC4.

#### Table OSC4 Office & Factory LAN Requirements and Potential Solutions

Potential technology options include higher performance lasers that operate at lower power or highly efficient modulators that enable encoding more information in a single wavelength. Furthermore, photodetectors and their amplifiers would need to operate at higher speed with lower energy per bit. Technology options to achieve higher data rates at lower power will be discussed in Section 7.

A second option for an optical interconnect LAN is “free space” optical interconnects (LiFi) which could operate using high data rate modulated LEDs<sup>1</sup> or lasers that are directionally controlled with mirrors or other means<sup>2</sup>. Several options exist for this technology which could use existing components, as shown in Table OSC3; however, the data rates may be significantly below those in fiber. One advantage of an LED system is that it could easily communicate with machines that are moved frequently<sup>1</sup>.

#### 5.4.2. WIRELESS LAN

Wireless will be used to communicate with computers, smart phones, smart appliances, tools, power management systems, and other IoT products, etc. Security will become an even more important issue to keep unwanted monitoring or malicious interference from outside wireless devices as more devices are monitored and controlled over the network.

### 5.5. DATA CENTERS

The 21st Century is clearly characterized by the explosion of requests for computing, storage and communication. This has been mainly driven by the worldwide spreading of fixed and mobile systems’ capabilities which have brought any kind of information, such as voice, data and video, available to anybody, anywhere and anytime.

Data Center infrastructure has become one of the faster growing areas for IT networking. Annual global data center IP traffic will reach 8.6 zettabytes (715 exabytes [EB] per month) by the end of 2018, up from 3.1 zettabytes (ZB) per year (255 EB per month) in 2013. Global data center IP traffic will nearly triple (2.8-fold) over the next 5 years. Overall, data center IP traffic will grow at a compound annual growth rate (CAGR) of 23 percent from 2013 to 2018<sup>3</sup>. A key requirement for Data Centers is the need for low cost, high performance, high density, and low power networking connections. In this environment, a dramatic ‘bottleneck’ is the difficulty in moving massive amounts of digital information, at each scale of dimensions: from worldwide links to chip-to-chip and even intra-chip interconnections.

## 8 Outside System Connectivity

While photonics may be already found at the heart of today's communication network providing high performance to trunk, metro and access systems, at shorter distances, the challenges implied by signals' speeds, power consumption, miniaturization and, on the whole, overall costs, are still partially addressed and relatively few, limited solutions are today available on the market. It is therefore foreseeable in the next 10-15 years that a huge evolution of optical interconnection systems and, consequently of opto-electronic devices, able to cope with Data Center requirements, will emerge.

For the sake of simplicity, we can separate the Data Center application areas into two categories: *Outside of Rack* and *Inside of Rack*.

### 5.5.1. OUTSIDE OF RACK

At this level, the issue of interconnecting the enormous number of server and storage equipment inside Mega Data Centers, for instance those built for Cloud Computing applications, is addressed. From the networking architectural perspective, a noticeable transition is underway from a rigid infrastructure interconnecting several levels of switches and routers with different capacity to a much flatter and more flexible mesh, the so called "spine-leaf" architecture which is able to directly link each rack to any other, in relatively large portions of the Data Center. This provides a considerable reduction in the latency of the overall system, providing much more effective services to the users.

In this scheme, for the rack-to-rack communication, different requirements may be drawn for at least 3 different transmission distances, indicatively: 10 meters, 500 meters and few (1 or 2) kilometers. The differentiation arises from the necessity to optimize the dimensions, the power consumption and the performance of different kind of transceivers, the so called *optical modules*.

Many module form-factors are currently adopted, for instance those belonging to CFP and QSFP families, which have become industrial standards. Such pluggable solutions provide the highest level of flexibility, in terms of quick upgrading of the optical ports' speed and easiness of interconnection to the optical infrastructure, through pluggable passive optical connectors. The choice of Single Mode Fiber has already been well accepted everywhere.

For the shortest range of distances, i.e. few tens of meters, an alternative solution can be the AOC (Active Optical Cable); in this case the E/O and O/E conversions are implemented inside the 'connector' of a fully terminated cable. These active connectors have the same form factor as many of the optical module connectors, e.g. CFP or QSFP, as shown in Figure OSC3. The user can therefore adopt this cabling system as a straightforward replacement of copper cables, but at much higher capacity and higher performance in terms of the signal integrity while reducing the size and power of the cabling.

Finally, the necessity to interconnect the Data Centers to the rest of the world calls for a different kind of transceiver modules, transmitting/receiving at much longer distance ranges (10's and 100' of kilometers). But these can be considered belonging to the Telecommunication segment.

For longer distance communication with optical modules, the data rates per lane (single wavelength) must increase as shown in Table OSC5. As data rate requirements increase and lower power is required with AOC [Table OSC5], the components must still fit into a very small form factor which will become increasingly difficult.

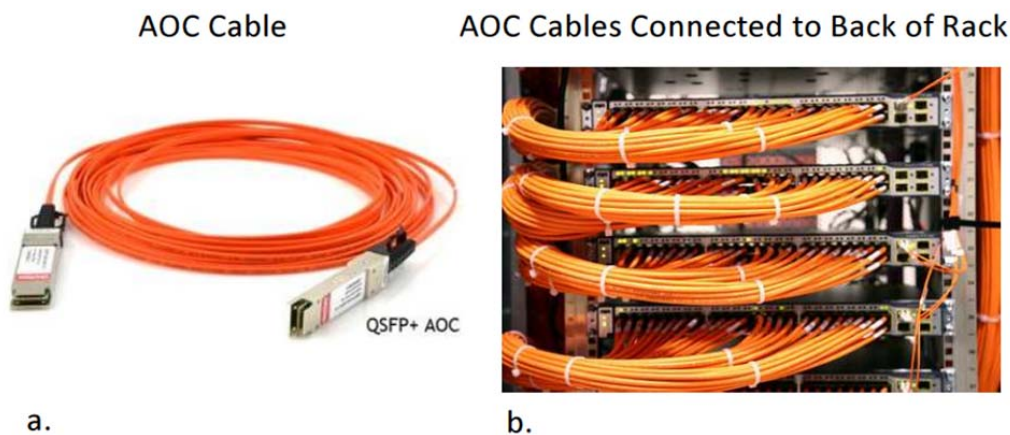

Figure OSC3. a. Active optical cable (AOC) and b. AOC connected to the back of a server rack in a data center.

**Table OSC5 Data Center Outside of Rack Requirements and Potential Solutions**

**5.1.1.1. THE BIGGEST CHALLENGES FOR FIBER OPTICAL OUTSIDE OF RACK COMMUNICATION**

The challenges are very similar for all the different kinds of optical transceivers listed above: in the first instance, dimensions of optical modules and power consumption, in terms of energy/bit reduction, are of paramount importance to provide an ever increasing throughput capacity at the front panels of racks/boards. Then, the performance, in terms of ever increasing bit rates and quality of signals, in terms of very low BER (Bit Error rate), are necessary to guarantee a fully reliable interconnecting mesh. Last, but not least, the low cost, in terms of \$/bit, is fundamental to make affordable and convenient to use photonics in this application area.

**5.5.1.2. POTENTIAL SOLUTIONS:**

Near term solutions include increasing data density in optical cables. The straightforward approach is actually based on the exploitation of a very large number of optical links, using SDM (Space Division Multiplexing). This would call for the fabrication of multiple opto-electronic transmitters and receivers, for instance in ‘array’ form.

In a medium timeframe (i.e. < 10 yrs.) WDM (Wavelength Division Multiplexing) will be necessary, with the ability to squeeze as many wavelengths as possible in the optical transmission bandwidth, as shown in Figure OSC4.

Moreover, HOM (High Order Modulation) techniques can be adopted to increase the spectral efficiency, providing very high speed transmission per lane (fiber or wavelength).

In the longer time frame (i.e. > 10 yrs.), if devices are developed that enable optically based switching and routing this could enable new types of architectures for communications within data centers, true optical routed networks, without intermediate optical-electrical-optical conversions, will be available.

At the basis of this evolutionary path will be, obviously, the availability of 2D and 3D opto-electronic devices. At the technological level the two key enabling building blocks will be the ‘traditional’ III-V compound based devices and the new Silicon Photonics based devices, recently appearing at industrial fabrication level, as shown in Figure OSC4.

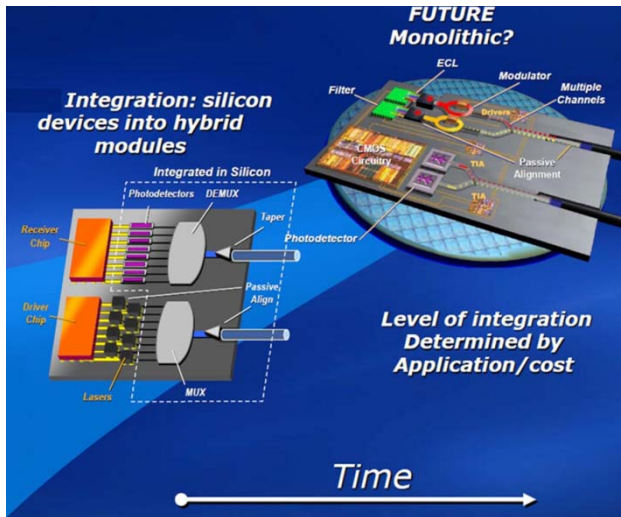

*Figure OSC4. Potential integration of advanced optical interconnect technologies over time. Presented by Intel at 2013 Intel Developers Forum.*

**5.5.2. INSIDE OF RACK**

Clearly, the enormous data rate throughput running across the Data Center, as described in the previous paragraph, is generated inside each piece of equipment in the Data Center itself. Copper is already showing big limits in terms of attenuation and available bandwidth and it becomes increasingly difficult to communicate at high data rates on PCB’s (Printed Circuit Boards) unless unsustainable power consumption levels are used. Optical interconnects will displace

## 10 Outside System Connectivity

copper interconnects over time. The optical interconnects will probably be used first for the backplane, then cards, and eventually the chip/package I/O, as illustrated in Figure OSC5.

At each stage of this transition, the opto-electronic components will need to be integrated into smaller form factor packages. Pure electronics and hybrid opto-electronic integration appear to be ineffective when a drastic level of miniaturization has to be realized, when performance at tens of Gb/s is to be met, and whenever the costs of implementation of pure optical devices, based on expensive materials, are to be drastically cut.

New efforts for advanced opto-electronic integration will be required to implement the so-called ‘embedded modules’. These type of optical transceiver modules will be fabricated in ultra-small dimensions, so that it will be possible to mount them very near (i.e.: < 1 cm) the big digital ASIC hosts. This arrangement will optimize throughput and will eliminate the power consumption implied by high speed copper interconnections.

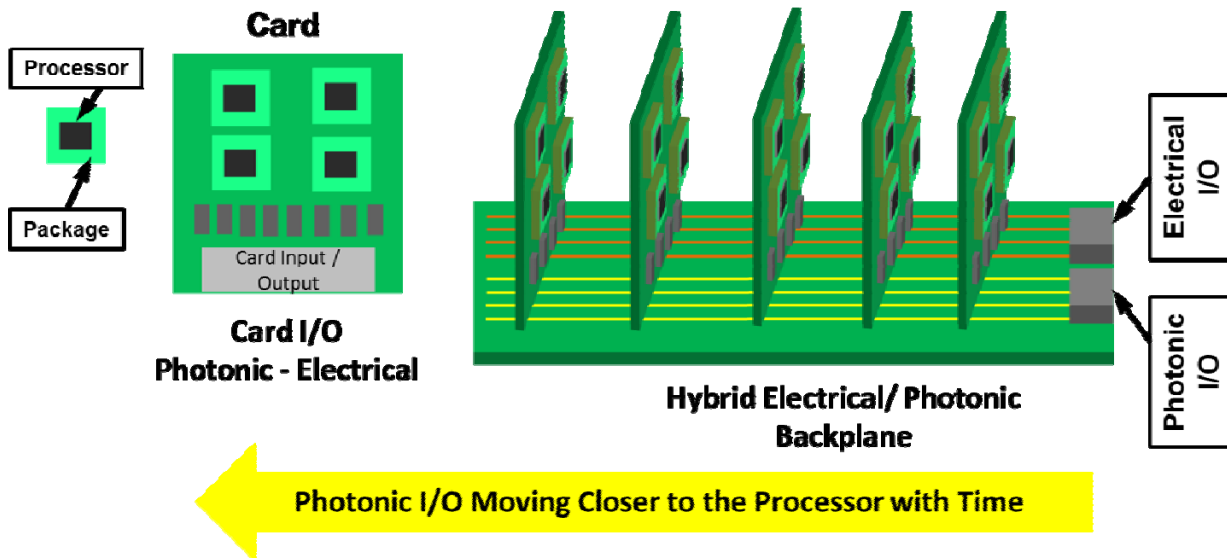

Figure OSC5. The evolution of optical interconnects to shorter distances depends on cost, data density, and added latency of the electrical-optical-electrical conversions.

### 5.5.2.1. THE BIGGEST CHALLENGES FOR OPTICAL INTERCONNECTS INSIDE OF RACK

The challenges are achieving the increased levels of miniaturization and energy dissipation/bit for the opto-electronics; moreover, the cost/bit will have to be comparable to that of copper based devices and systems for a widespread adoption, as shown in Table OSC6. From the pure optical point of view, the coupling of optical signal with fibers and waveguides will become crucial for the good operation, at the required industrial reliability.

Table OSC6 Data Center Inside of Rack Requirements and Potential Solutions

### 5.5.2.2. POTENTIAL SOLUTIONS

Near term solutions will adopt ‘embedded-modules’ with optical fiber pig-tails. According to the availability of optical PCB boards this kind of ultra-compact transceivers will evolve with the capability to avoid interfacing with optical fibers while interfacing directly with ‘optical’ PCB embedding waveguides that will substitute for copper traces. In even longer timeframes, the final goal will consist of embedding optical I/O’s in the digital ASIC’s: optics will definitively support all communication among VLSI devices.

For sub-meter distances optical interconnection will be a real must. In this perspective, Silicon photonics technology looks very promising for its peculiar characteristic of bringing optical and electronic functions together inside ‘traditional’ silicon technology. Proper yield and quality is available using the very well established large scale semiconductor manufacturing infrastructure and tools chain. In the near future a commoditized use of the silicon photonics technology, as presently happens for traditional VLSI market will be available on the market.

At the same time the full range of optical devices will evolve: long term novel laser structures, electro-optical modulators or novel Mach-Zehnder, or plasmonic Mach-Zehnder, modulators and detectors are needed, as shown in Table OSC6 potential solutions. For lasers, it is important to reduce energy dissipation, increase optical power output and increase

operating frequency for direct modulation. For modulators, it is critical to increase on/off ratio, to reduce size, to have high operating frequency, energy dissipation and optical loss.

Free space optical interconnects have been proposed for communications between cards on the backplane<sup>4</sup>

### 5.6. TELECOMMUNICATIONS

Telecommunications will continue to support increasing data volumes both to Data Centers, Offices, and FTTX to support home users. To support this increased volume of data, the data rate per wavelength will need to increase from the current 200Gb/sec-wavelength to 1000Gb/s.-wavelength in 2029. The maximum data rate per fiber will increase from 50Tb/s to 250Tb/s in 2023 as shown in Table OSC7, which requires over 100 wavelengths per fiber and modulation of polarization and higher order modulation. The telecommunication industry is leading the development of these technologies.

Table OSC7 Telecommunications Optical Interconnect Requirements

### 5.7. SMALL BUSINESS OR HOME

Scope: Small business offices, small stores, small medical offices, and homes

#### 5.7.1. FTTX

FTTX uses fiber to “feed” copper to provide the last 1-2 km of the data and tele-communication connections to the end user. As data rates have increased, providers have extended fiber closer to the end user to overcome limitations of copper interconnects. While the downlink data rate is only expected to increase from the current 10GB/s-wavelength to 25GB/s-wavelength, the maximum number of wavelengths per fiber is expected to increase from 3 to 32, as shown in Table OSC8. As the fiber is extended closer to the user, multiple wavelengths in the fiber will need to be separated by a deMUX in contact with the fiber. Furthermore, the signals launched from the user will need to be duplexed with other wavelengths in the fiber returning data to the communication switching center.

Table OSC8 Fiber to X (FTTX) Requirements and Potential Solutions

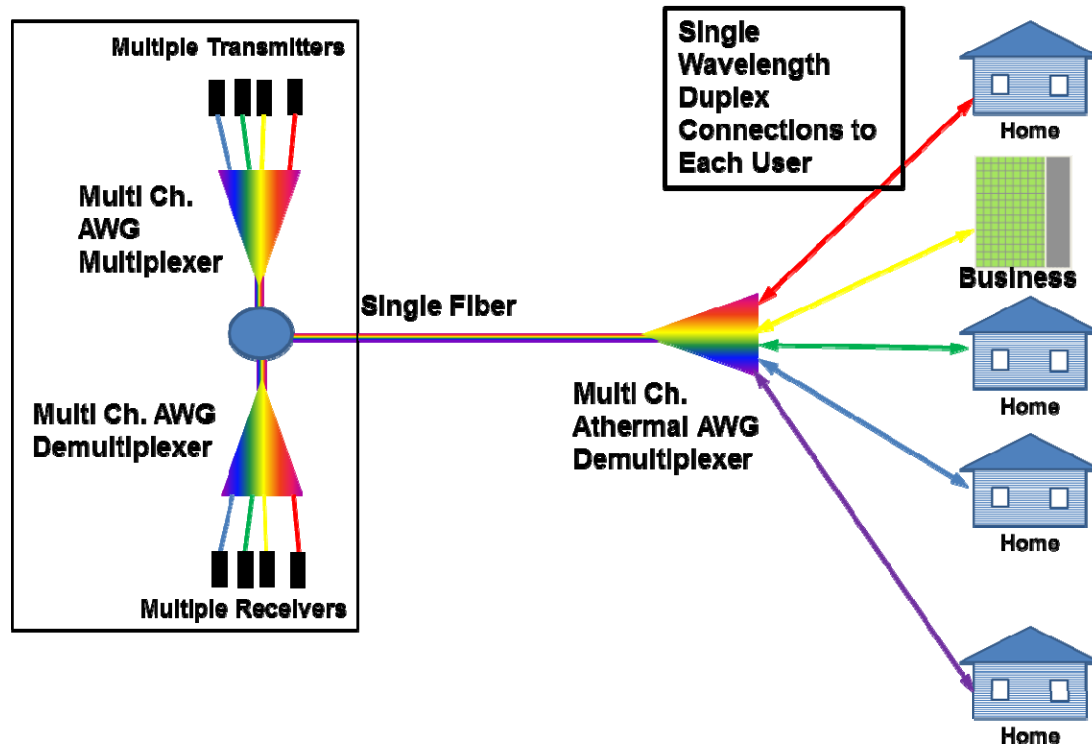

Figure OSC6. Potential path for FTTX extending further from the Telecom Office to businesses and homes. This requires wavelength division multiplexing(WDM) and demultiplexing closer to the point of service delivery. Electrical wires may be used to deliver the last length of connection to some customers.

## 12 Outside System Connectivity

The biggest challenges for the FTTX optical interconnects are to develop cost effective compact MUX and deMUX capabilities that can split compactly separate wavelengths and merge wavelengths from users to the switching office.

Potential solutions include developing compact Mach Zehnder MUX and DeMUX capabilities based on plasmonic technology or other compact technologies. It is assumed that other improvements in lasers, detectors and modulators to support Data Centers and Office LANs can be adopted to support FTTX. Compact integration technologies to support integrating modulators in AOC can be adapted to support FTTX applications.

### 5.7.2. WIRELESS

In these environments, data and communication may be delivered to the office or home with wire, optical fiber, or wireless, but wireless will most likely be used to connect to computers, smart phones, smart appliances, tools, business terminals, power management, environmental monitor and control systems, and IoT products. This includes applications such as exercise and health monitors and passive activity monitors for elderly citizens. With increasing numbers of devices communicating to and through these networks, the routers will need to communicate with a range of protocols and have ever increasing bandwidth. Security will become an even more important issue to keep unwanted monitoring or malicious interference from outside wireless devices as more devices are monitored and controlled over the network.

### 5.8. AUTOMOTIVE

Scope: Automobiles, trucks, freight trucks, heavy equipment, and farm equipment

Auto vehicles will use wireless systems to communicate with networks, determine position and detect proximity to objects and vehicles. This could include RF, microwave, “radar”, optical range detection, and video. Communication of information from sensors and guidance detectors will require significant amounts of data to be transmitted and analyzed which will require use of high bandwidth optical or wired connections, as shown in Figure OSC7.

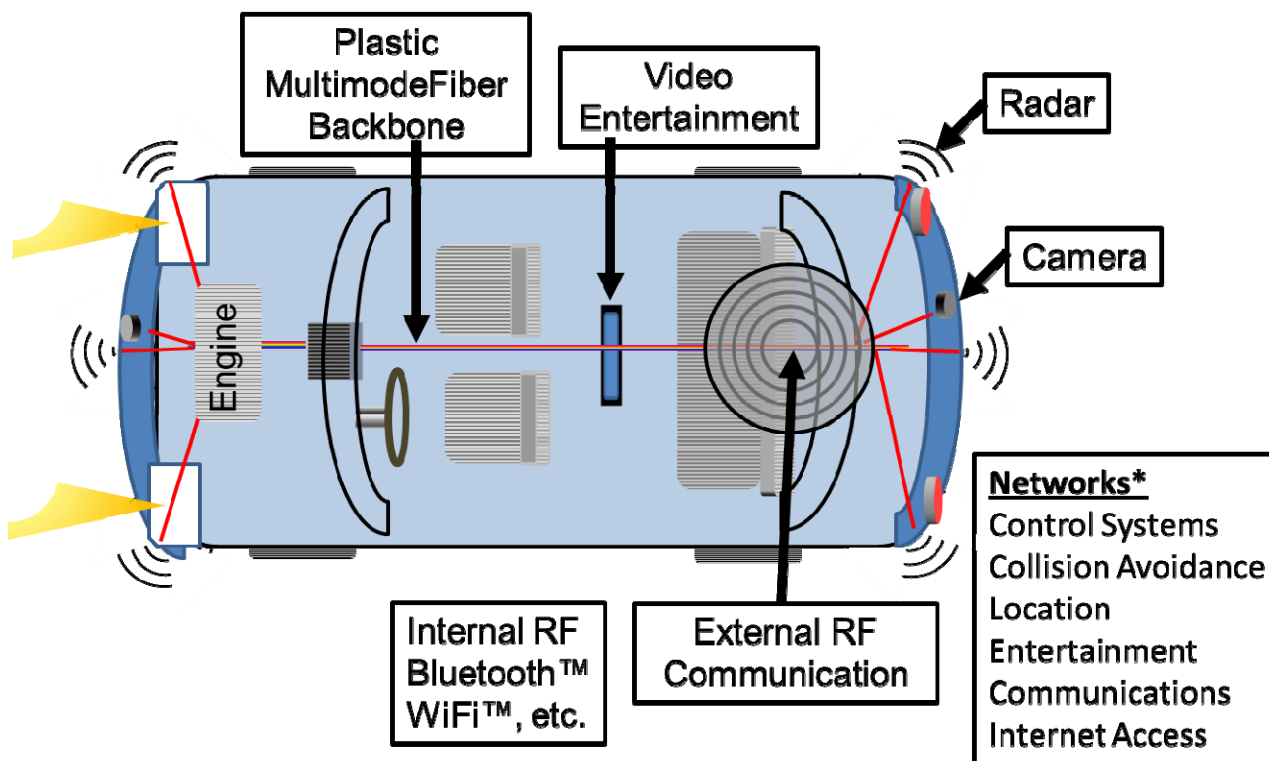

*Figure OSC7. Automobiles have multiple networks to measure performance, detect obstacles, control operation, deliver entertainment to the passengers, and provide communication to the “Cloud”. As networks expand, there will be a move to reduce the use of copper and increase the use of low weight optical fiber interconnects with increased data rates and information density.*

### 5.8.1. WIRELESS

As auto vehicles strive to become more autonomous, more wireless capabilities will be employed to communicate with traffic networks, detect and monitor vehicles, pedestrians, animals, bicycles, obstructions, highway construction, and weather related hazards, etc. This would include GPS and radar like detectors to monitor proximity, trajectory and speed of vehicles, pedestrians, animals, etc. Also, this information would be coupled with video and image recognition to determine expected actions of the objects. For the radar like devices, different frequencies may be used to determine the density of objects. As auto vehicles become more autonomous, the demand for high speed communication, data, and entertainment media will increase. Within the vehicle, a WiFi like network will be used to communicate with portable devices including computers, phones, watches and possibly health monitors.

### 5.8.2. OPTICAL NETWORKS

With automobiles having more electronics and sensors for more autonomous driving vehicles, there is a need for high data rate low weight communication networks. As a result, automobiles are using plastic optical fiber communication to reduce weight and increase data rates. Over time, the data volumes are expected to increase as more sensors including cameras, radar, environmental sensors, and engine performance sensors are added to identify obstacles and improve automobile performance and comfort. To support this, data rates in fibers will increase from 20Gb/s to 40Gb/s in 2019, as shown in Table OSC9. It is assumed that current and developing technologies will be able to support these data rates in the required timeframe.

#### Table OSC9 Automotive Optical Interconnect Requirements

Free space optical may be used to provide information on proximity to other vehicles through lighting system modulation.

The biggest challenges will be to meet the environmental requirements for different applications which will require robust packages to manage shock and vibration, temperature extremes, etc. In addition, the fiber optic networks will need to meet significant cost challenges, which will require increasing levels of integration at the package and then device level. These increasing levels of integration can be supported by technologies developed to support Office LAN and Data Centers.

### 5.9. AEROSPACE

Fiber optics and wireless communication are being used in aircraft applications to reduce weight and increase bandwidth for a range of applications. Applications include entertainment, in flight networking, display systems and RF over fiber communication. In-flight entertainment can be transmitted over fiber to a “box” near the seats. For in-flight networking, data can be transmitted over fiber or free space optical to WiFi stations or seat consoles that communicate with customer portable or mobile devices. Furthermore, data from sensors and potentially control systems can be communicated over fiber optics to the pilots. Fiber optics communication has several advantages over conventional copper wires including lower weight, electromagnetic interference immunity and smaller size.

High flying drone like aircraft are also being developed to provide internet access with RF over large areas while the circling over an area needing access.

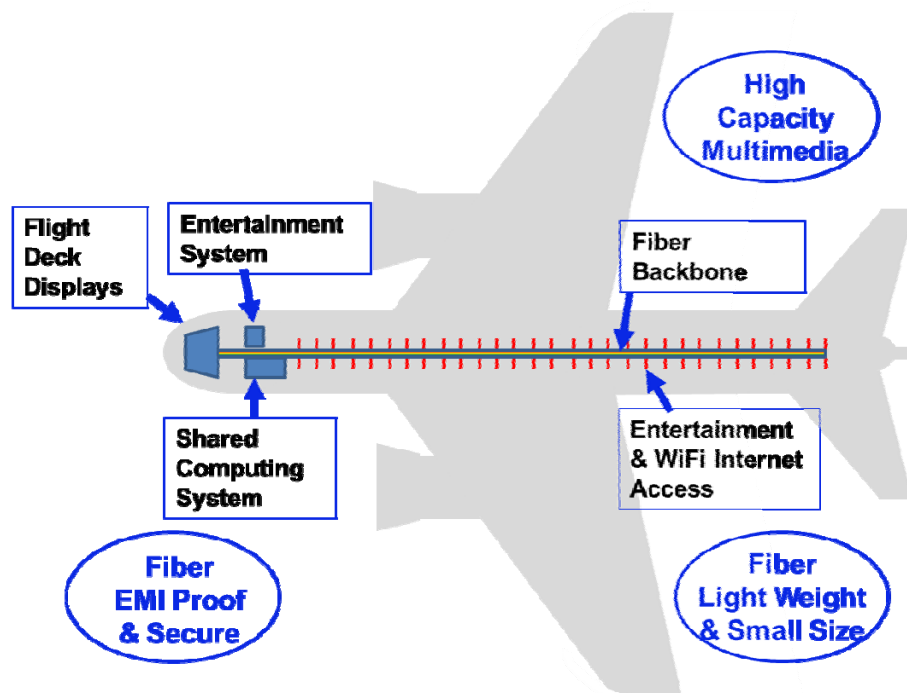

Figure OSC8. Optical interconnects can provide interconnects for internet connectivity and multi-media entertainment distribution and in the future flight deck with computing resources, switches and actuators, and sensors in the aircraft.

Free space optical interconnects are being proposed to provide communication, internet access, and entertainment to passengers in aircraft to reduce cost and avoid installing fiber in barriers<sup>5,6</sup>. Free space optical interconnects are also proposed to support internal avionics communication<sup>7</sup> because the signals are secure from outside detection. These interconnects could use white LEDs, lasers, etc. and are immune from EMI, are low weight, low cost, and low power.

Currently, fiber optic communication is available in aircraft to operate at 10Gb/s in multi-mode or single mode and with wavelengths of 850nm, 1310nm, and 1550nm, Table OSC10. Fiber optic devices in aircraft must be able to operate in harsh environments with thermal shock, mechanical shock, extreme temperatures (-40 to 125C) and devices must be protected from lightning strikes. It is anticipated that more applications will emerge related to increased use in control systems.

**Table OSC10. Aerospace Optical Interconnect Requirements (Preliminary)**

Fiber optic systems are also being investigated for use as sensors of stress and cracks in aircraft structural components including wings, the fuselage, and in turbine blades. Currently, these sensors have a local electro-optic measurement module, but wider use of optical networking in future aircraft could enable longer distance monitors of the strain monitors.

The biggest challenges will be meeting environmental requirements (shock & vibration, temperature extremes, thermal shock, etc.) for fiber optic transducers placed in environmentally exposed locations. This will require development of robust packaging technologies and components. Optical components for transmitters and receivers currently under development for other applications should be able to meet performance requirements.

It is also proposed that high flying drone like aircraft may be used to provide internet communication with wireless technology, as is shown in Figure OSC9.



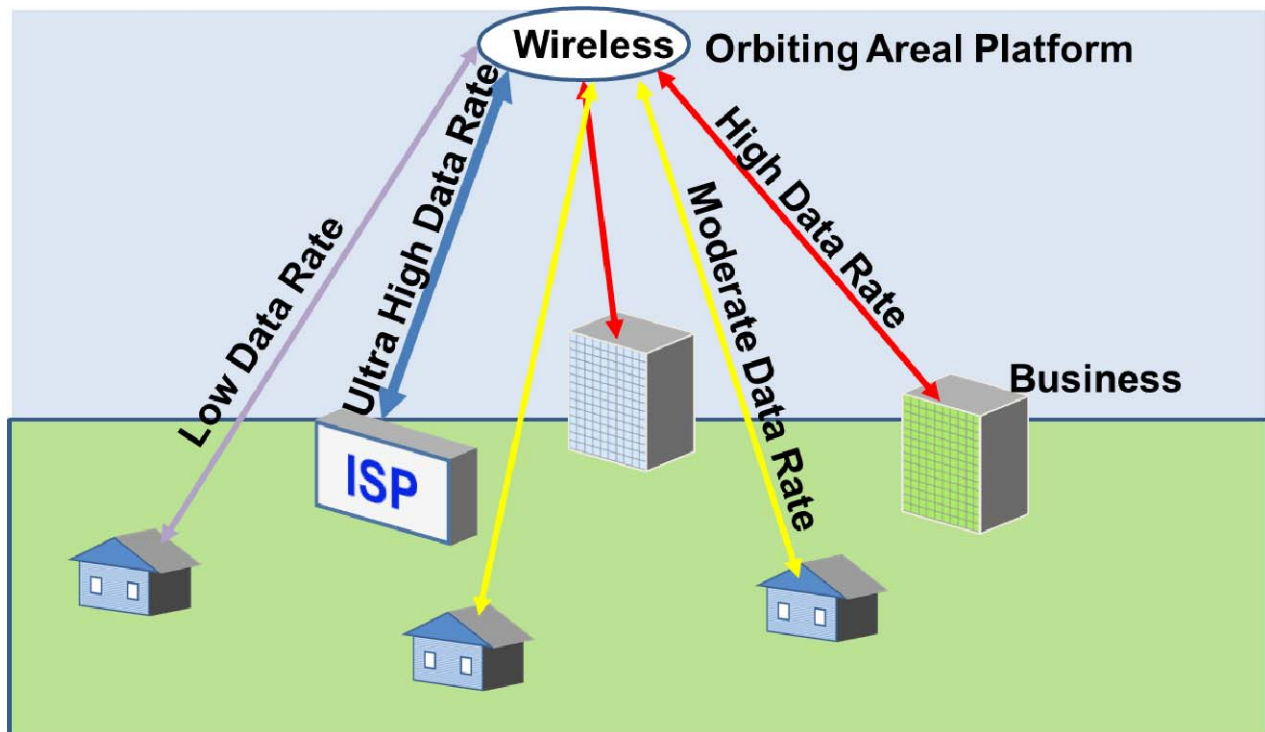

Figure OSC9. An example of a wireless flying network hub that would provide internet connectivity to metropolitan or rural areas. An aircraft would “orbit” or “hover” over a specific location out of commercial flight paths and provide services to businesses and consumers.

We are seeking additional input from the aerospace industry on future requirements.

## 6. RF & Analog and Mixed Signal (AMS) Technology

### 6.1. INTRODUCTION

The RF & AMS introduction is in section 4.1.

### 6.2. TECHNOLOGY REQUIREMENTS

#### 6.2.1 RF CMOS

The 2015 roadmap technology plots reflect the RF and analog performance metrics needed to support the technology roadmap developed by the ITRS Process Integration, Devices, and Structures (PIDS) Working Group in 2015. The RF-AMS performance metrics for CMOS devices have been restricted to  $f_T$  (Fig. OSC10) and  $g_m$  (Fig. OSC11) and have been calibrated on recent measured data in the 28nm, 22nm and 16nm nodes. The 2015 roadmap gives, for the first time, the above performance FoMs for n-channel FDSOI and double-gate FinFET high-performance devices obtained from technology for computer assisted design (TCAD)-based process and device modeling methods. These include hydrodynamic and thin silicon mobility physics, as well as the estimated resistive and capacitive device parasitics up to the first metal layer, relevant to high-frequency analog circuit design. Compared to previous editions of the ITRS, the new  $f_T$  data provide a more realistic view of the projected high frequency performance of future MOSFET devices down to physical gate lengths of 7nm. They indicate the degradation in  $f_T$  and  $g_m$  at gate lengths below 10 nm as a result of mobility degradation caused by surface scattering at the gate oxide interface and due to the ever thinner silicon body. As can be observed, the double gate of the FinFET results in higher transconductance but also higher capacitive parasitics compared to the single-gate FDSOI MOSFETs. Other MOSFET high frequency figures of merit, such as  $f_{MAX}$  and  $NF_{MIN}$  which are strongly dependent on designer layout preference and parasitics in the upper metal layers of the back-end, have been removed from the CMOS section of the OSC tables. To associate the evolution of  $f_T$  and  $g_m$  with the technology

## 16 Outside System Connectivity

nodes and years of introduction, please follow the PIDS tables which chart physical gate length vs. technology node and year of introduction.

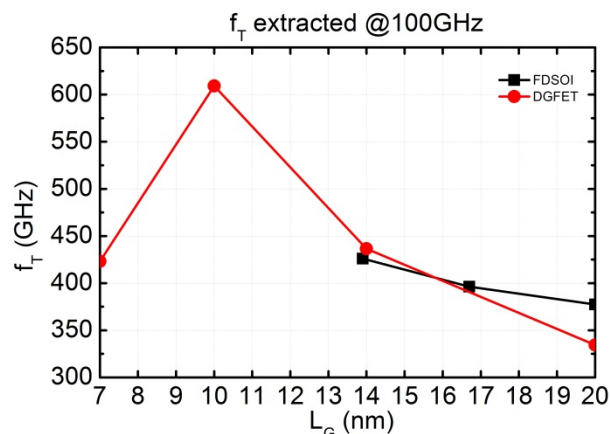

Figure OSC10. CMOS Roadmap for peak  $f_T$  vs. physical gate length for FDSOI and double-gate (FinFET) MOSFETs based on technology CAD and PIDS data

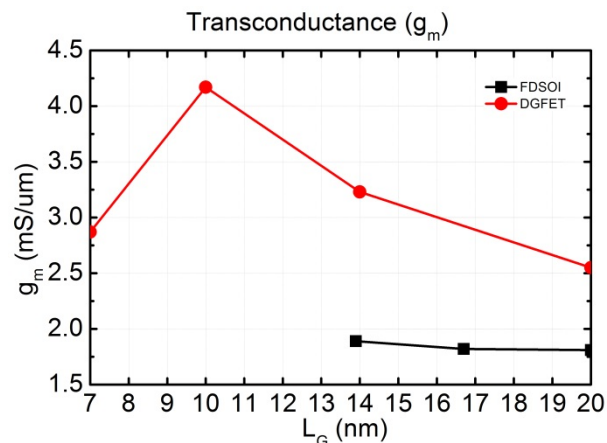

Figure OSC11. CMOS Roadmap for transconductance per unit gate width,  $g_m$ , vs. physical gate length for FDSOI and double-gate (FinFET) MOSFETs based on technology CAD and PIDS data.

### 6.2.2. GROUP IV BIPOLAR

The roadmap for SiGe heterojunction bipolar transistors (HBTs) and associated benchmark circuits at mm-wave frequencies has been based since 2013 on a seamless set of TCAD device simulation tools in order to obtain consistent compact model parameters for the complete transistor structure used in the respective circuit simulations. All known transport, structural parasitic and temperature effects have been included in the results. Furthermore, the TCAD tools and those parameters that cannot be obtained by TCAD have been calibrated on existing prototyping process technologies. The data (including the minimum emitter width  $W_E$ , and all electrical performance parameters such as  $f_T$ ,  $BV_{CEO}$ ,  $BV_{CBO}$ ,  $J_C$  at peak  $f_T$ ,  $NF_{MIN}$ ,  $MAG$  etc.) in the 2015 Technology Requirements Tables for high-speed NPN transistors have been shifted by one-year, as shown in table OSC11. Performance plateaus have been assumed to last 4 years and are linked to applications and the foregoing system drivers. It has been assumed that at least two foundries offer the technology of the respective node for product prototyping are presented. The benchmark circuits for LNA, PA, VCO, and current-mode-logic-based (CML) ring-oscillator (RO) have been manually optimized for each technology node and a variety of commercially relevant frequencies.

Table OSC11 RF and Analog Mixed-Signal Bipolar Technology Requirements

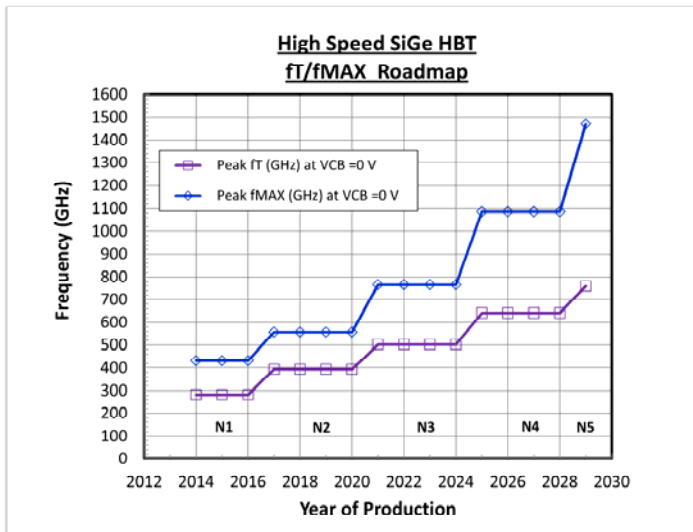

Figure OSC12. High Speed SiGe HBT fT and Fmax Roadmap vs. Year of Production

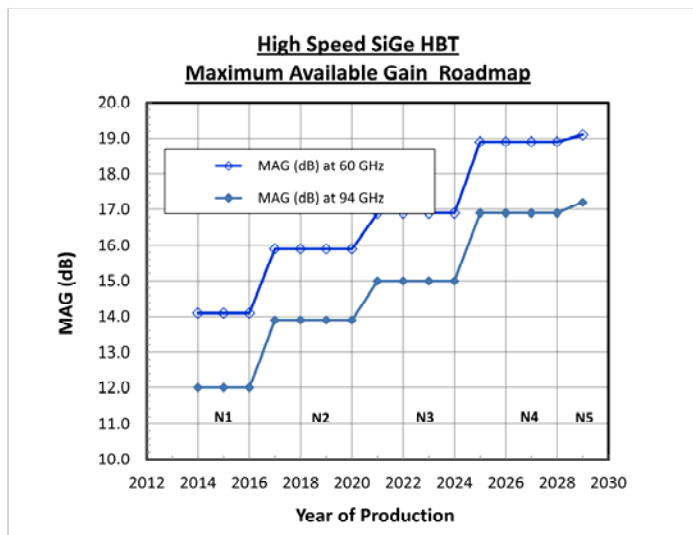

Figure OSC13. High Speed SiGe HBT Maximum Gain Roadmap vs. Year of Production

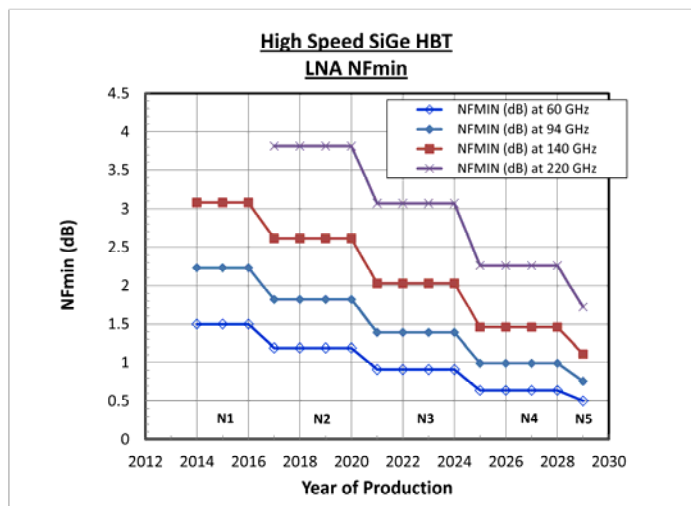

Figure OSC 14. HBT minimum noise figure with ideal reactive components vs. year of production

### 6.2.3. GROUP III-V COMPOUND SEMICONDUCTORS CONSISTING OF ELEMENTS FROM GROUPS III AND V [BOTH BIPOLAR AND FIELD EFFECT TRANSISTORS (FET)]

We have assumed “production” implies that at least one company offers products with “data sheets” or that the technology is available for custom designs from one or more companies as a foundry service. The production dates for all technologies have been shifted by one year later. The ‘pull’ for these technologies partly drives this shift. The III-V roadmap truncates at the following expected ends of scaling: GaAs pseudomorphic high electron mobility transistor (PHEMT) in 2015, GaAs power metamorphic high electron mobility transistor (MHEMT) in 2020, and InP power high electron mobility transistor (HEMT) in 2016. However, we expect that low noise GaAs MHEMT and InP HEMT, InP HBT, and GaN HEMT will continue with physical scaling. The 2012 Update, as in the past, has only D-mode field effect transistor (FETs). E-mode devices are in the 2013 and 2014 updated roadmaps. The FoMs depend on technology and will include:  $f_T$ ,  $f_{MAX}$ ,  $g_m$ , and  $V_{BD}$ ; power, gain, and efficiency at 10, 24, 60, 94, 140, and 220 GHz;  $NF_{MIN}$  and  $G_A$  at 10, 24, 60, and 94 GHz; LNA NF and  $G_A$  at 140 and 220 GHz, as shown in table OSC12 and figures OSC15-OSC18. As mentioned previously, RF and AMS front-end components are a growing part of the semiconductor industry. However, this has divided the III-V technology landscape into two groups, one dominated by the large volume consumer market and the other dominated by low volume specialty markets. Within the III-V technology landscape, the large volume consumer driven market is best represented by GaAs HBT power amplifiers for cellular communications. Here the dominant driving force has become cost, and there is only a marginal device performance improvement from year to year. The low volume specialty markets to which InP HEMT, InP HBT, and GaN HEMT presently belong also suffer from the slow pace of innovation, or more importantly, a slow transition to mass production due to low product volumes. Many of these technologies are driven by non-commercial needs and experience sudden leaps in performance only when government funding becomes available. For these reasons, the value of the III-V roadmap has been called into question. This sub-group seeks greater industry participation and immediate input concerning the III-V technology roadmap and priorities.

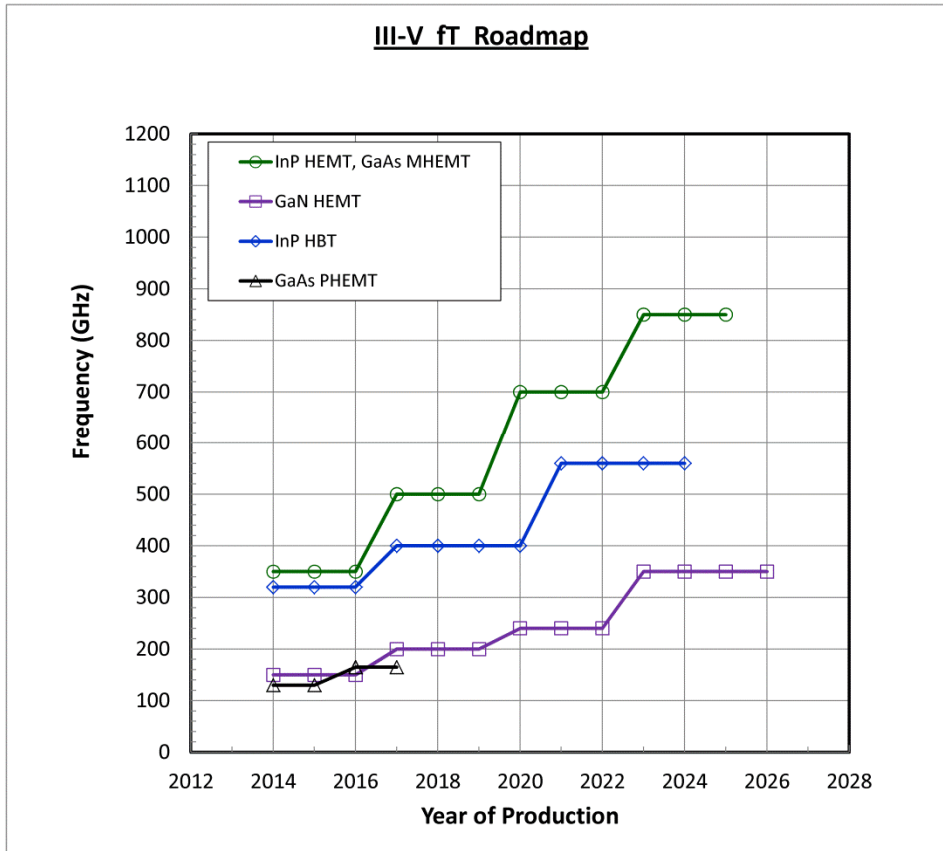

Figure OSC15. III-V Roadmap for fT

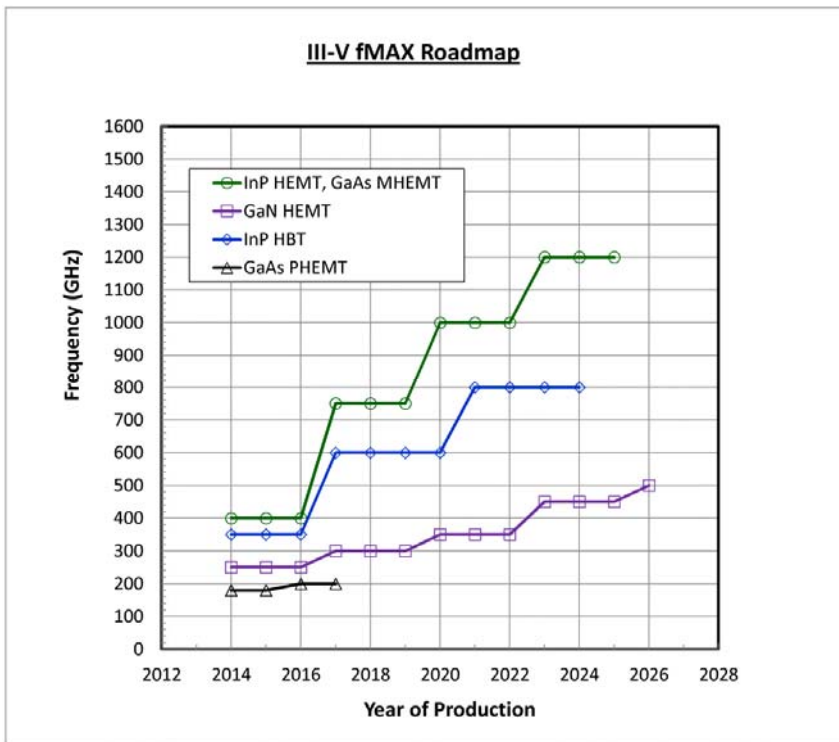

Figure OSC16. III-V Roadmap for fMAX

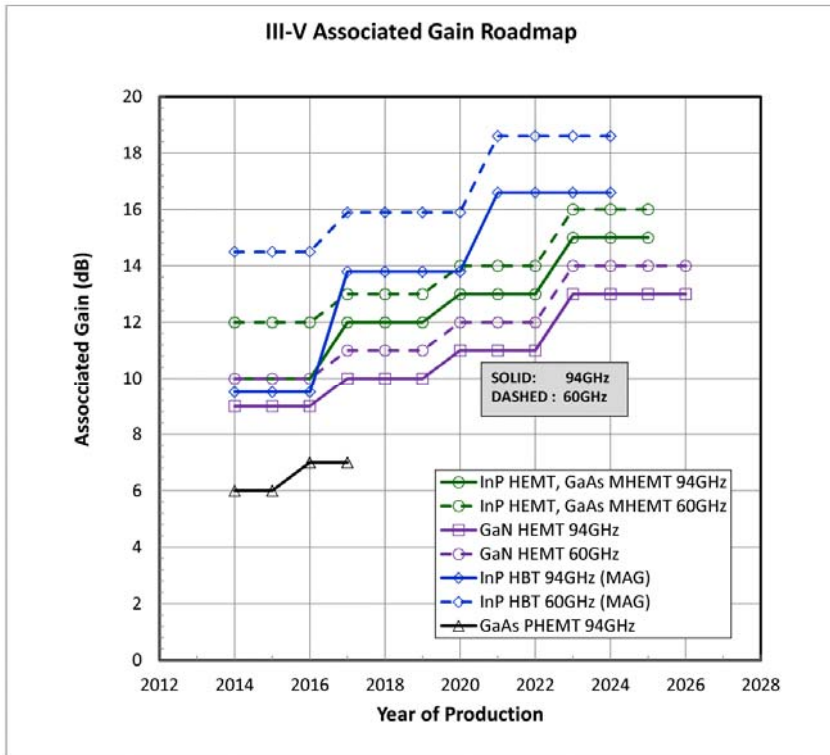

Figure OSC17. III-V Roadmap for Associated Gain

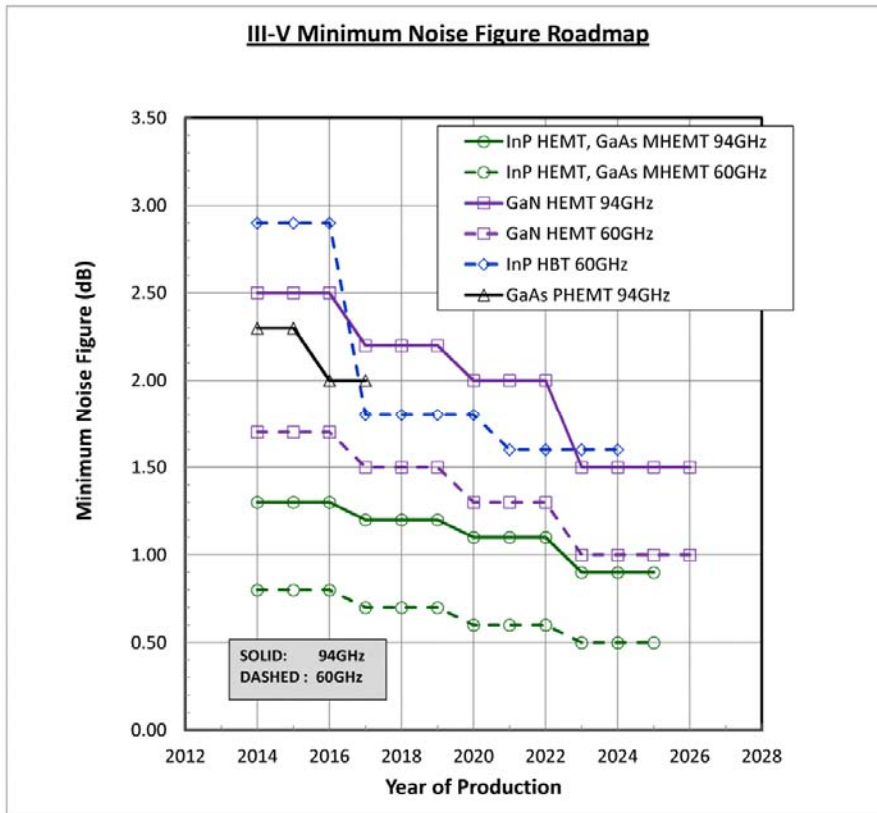

Figure OSC18. III-V Minimum noise figure roadmap

**Table OSC12 Group III-V Compound Semiconductor FET and Bipolar Transistors Technology Requirements****6.3. RF & AMS DIFFICULT CHALLENGES****Table OSC13: Difficult Challenges**

RF and Analog/Mixed-Signal (RF and AMS) Technologies	Summary of Issues
<b>Difficult Challenges</b>	
<b>CMOS Technologies</b>	Many of the materials-oriented and structural changes being invoked in the digital roadmap degrade or alter RF and analog device behavior. Complex tradeoffs in optimization for RF, HF, and AMS performance occur as different mechanisms emerge as limiting factors. Examples include series resistances at gate, source and drain, that greatly affect parasitic impedances and the impact of such local interconnect parasitics on $f_{MAX}$ . Fundamental changes of device structures, e.g., multiple-gates and silicon-on-insulator (SOI), to sustain continued digital performance and density improvements greatly alter RF and AMS characteristics. Such differences, along with the steady reduction in supply voltages, pose significant circuit design challenges and may drive the need to make dramatic changes to existing design libraries.
<b>Group IV Bipolar Technologies</b>	Even though it is a challenge for the HS-NPN to increase the unity current gain cut-off frequency $f_T$ by more aggressive vertical profiles, it is less of a challenge to achieve $f_{MAX} > f_T$ . What is unclear today is, how large the ratio $f_{MAX}/f_T$ needs to be for future circuit applications. That is, the challenge is to determine what this ratio should be by using the "plateau" technologies" for the next roadmap and appropriate benchmark circuits. Since lateral scaling requirements for HBTs are significantly relaxed compared with those for MOSFETs, vertical profile fabrication under the constraints of overall process integration appears to be the bigger challenge. The reduction of imperfections and the increase of current carrying capability of the emitter and collector contact metallization are further challenges that need to be met by process engineers on the way to achieving the physical limits of this and any other technology.
<b>III-V Compound Semiconductor Technologies</b>	The unique challenges are yield (manufacturability), substrate size, thermal management, integration density, dielectric loading, and reliability under high fields. Challenges common with Si-based circuits include improving efficiency and linearity/dynamic range, particularly for power amplifiers. A major challenge is increasing the functionality of power amplifiers in terms of operating frequency and modulation schemes while simultaneously meeting increasingly stringent linearity requirements at the same or lower cost.

**6.3.1. RF & AMS INFRASTRUCTURE CHALLENGES**

RF and AMS technologies have critical roles to play in their contributions to the 2015 roadmap being developed by the ITRS 2.0 Focus Team on Outside System Connectivity (OSC). One key role for the RF and AMS community is enabling energy efficient and interoperable capabilities through standards for the Internet of Things, the first component for the Internet of Everything - both tethered and untethered - and the next generation of the Cloud (Cloud 2.0). Many of the promoters of the IoT and Cloud 2.0 tend to concentrate more on the software/design/architecture side at the expense of the hardware/components side. The recent IEEE-SA / MIG Press Release<sup>8</sup> gives a few societal applications of the IoT/IoE and the role of RF and AMS devices, components, and systems in providing the basic building blocks. Accelerating the successful commercialization of the basic building blocks for the IoT/IoE depends in part on developing technology roadmap on the following potential showstoppers:

1. Measurements and standards to access the radio frequency interference (RFI) and electromagnetic compatibility (EMC) figures of merit (performance attributes) of more energy efficient LNAs, VCOs, PAs, ADC, DACs, SerDes Converters (ADC), switching power supplies, and the like. Energy efficient switching power supplies, such as those based on GaN and SiC, and LEDs for photonic communications tend to be very EM and RF noisy for the precision analog circuits that are critical for the success of the IoT, especially, for MEMS-based sensors and actuators. RFI is a serious concern and in fact an increasing one because more sensitive electronics are used now and the RF environments in which

## 22 Outside System Connectivity

they have to work have become extremely harsh. MEMS, RF and Analog/Mixed-Signal (AMS) components, and power electronics are becoming very synergistic. Two of many examples are vehicle to vehicle (V2V) and vehicle to pedestrian with smartphone (V2PS) WiFi communications for collision avoidance and for traffic/pedestrian control. The success of the IoT and future Cloud generations (e.g., Cloud 2.0) depends on how well MEMS, RF and AMS components, and power electronics work together.

2. Establish an international RF and Analog/Mixed-Signal Industry Group (RFIG) (a trade association) in collaboration with a standards development organization (SDO) such as the IEEE-Standards Association (SA) to establish priorities for standards and associated measurements to address the challenges in item 1 above.

3. Metrics for assessing the reliability and durability of the communications components/hardware used in item 1 above, especially MEMS sensors and RF MEMS components for healthcare and medical applications. The International Electronics Manufacturing Initiative (iNEMI) has two projects on the reliability of implanted medical electronics and portable electronics. Both iNEMI projects have completed surveys and webinars. The surveys provide guidance on how OSC could respond<sup>9-11</sup>.

4. Use of vehicle-based communications nodes during emergencies. As a result of the tsunami in Japan, many Japanese car manufacturers are collaborating with the Japanese government to use cars and other vehicles as communication nodes during times of emergency - much short-term energy (batteries and fuel) is available in vehicles to power emergency communications networks and temporarily replace the mainstream IoT infrastructure. Members of the ITRS Focus Team on Outside System Connectivity (OSC) will take a lead in developing appropriate technology roadmaps for the hardware components used in emergency IoT networks.

### 6.4. POTENTIAL SOLUTIONS

#### 6.4.1. CMOS POTENTIAL SOLUTIONS

Potential solutions for CMOS performance difficult challenges are covered in the More Moore Chapter.

#### 6.4.2. GROUP IV BIPOLAR/BICMOS POTENTIAL SOLUTIONS

For the group IV bipolar devices, a number of potential solutions are under evaluation including improving process steps and new device architectures as shown in figure OSC19.

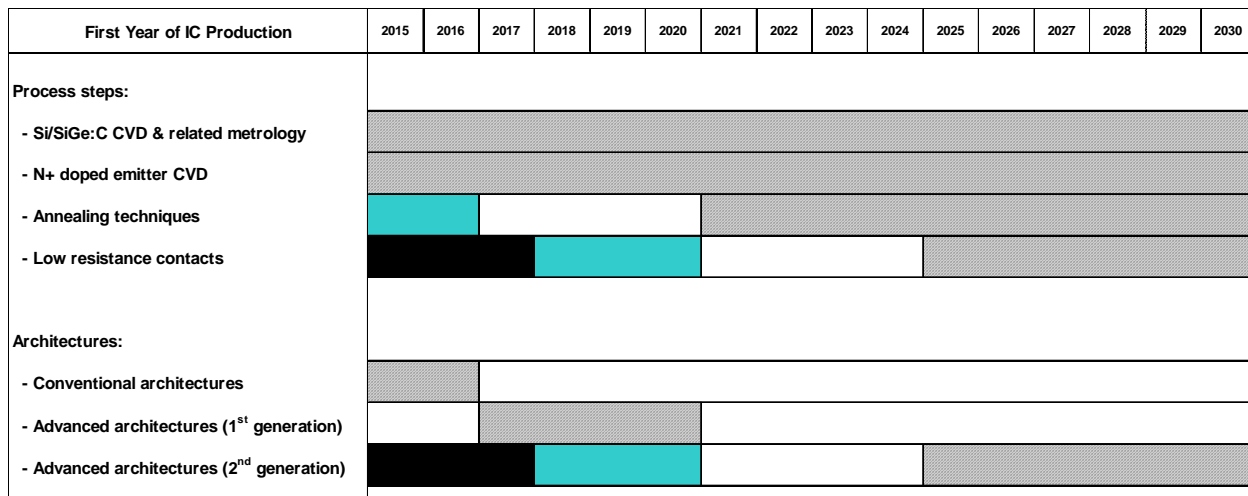

This legend indicates the time during which research, development, and qualification/pre-production should be taking place for the solution.

Research Required  
 Development Underway  
 Qualification / Pre-Production  
 Continuous Improvement



Figure OSC19. High-Speed SiGe BiCMOS Potential Solutions



### 6.4.3. GROUP III-V COMPOUND SEMICONDUCTORS CONSISTING OF ELEMENTS FROM GROUPS III AND V [BOTH BIPOLAR AND FIELD EFFECT TRANSISTORS (FET)]

For Group III-V devices, potential solutions under evaluation include improved thermal management, new epitaxy and substrates, device scaling technologies, heterogeneous integration on silicon, high throughput e-beam lithography, and multilevel interconnects, as shown in figure OSC20. More detailed descriptions of these can be found in the 2013 ITRS RF & AMS Chapter, although details are outdated.

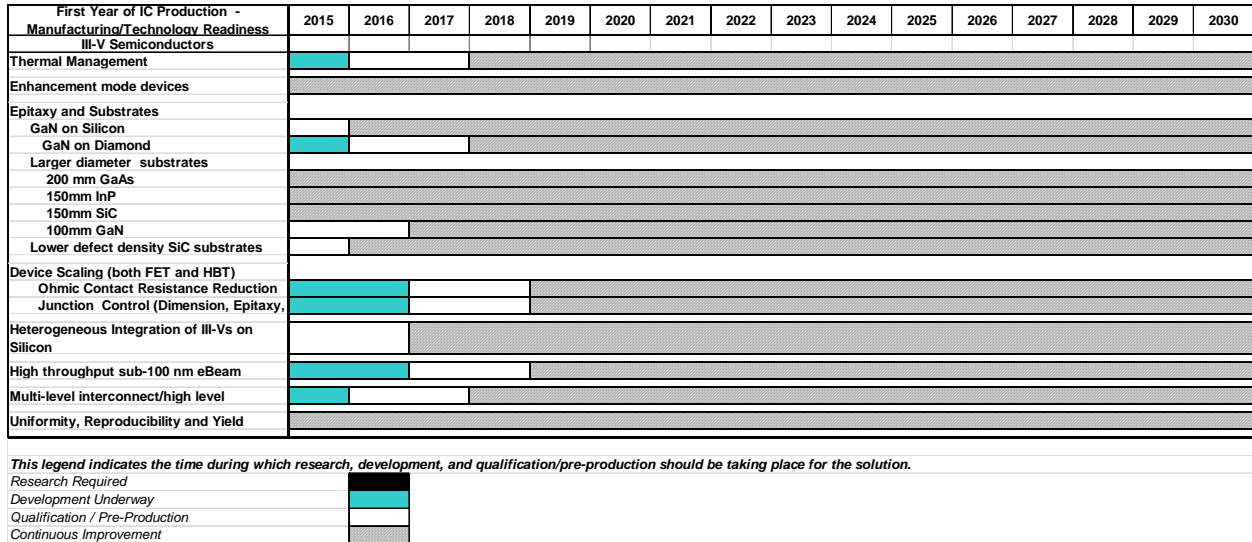

Figure OSC20. Group III-V Compound Semiconductors Potential Solutions

## 6.5. SECURITY

As was highlighted in the applications section, developing secure wireless communication systems is critical to eliminate eavesdropping and hacking of the wireless communication. Currently, most solutions employ encryption and software based solutions; however, these are not adequate by themselves. Research is currently underway to identify viable physical layer of security that could work in conjunction with encryption and software. It has been proposed that multiple antennas be employed using interference alignment<sup>12</sup>, multiple antenna relaying technologies with multiple-input-multiple-output (MIMO)<sup>13</sup>. A different approach uses zero forcing beam forming to enable secure WiFi<sup>14</sup> by using one beam to communicate while a second beam is actively “blinding” potential eavesdroppers. These approaches employ multiple antennas to communicate, but there may be efforts to employ smart antennas to perform the same functions. Other proposals include networks that route information through multiple wireless paths and break the information into smaller segments<sup>15</sup>. Some of these models may be viable for high value applications such as automobiles, but mobile phones and sensor networks may require less costly solutions. Thus, different models may be employed for different applications.

For sensor networks, different approaches are evaluating different routing schemes to confuse potential eavesdroppers. One approach uses a pairwise key predistribution scheme to change the routing of data in a seemingly random patterns<sup>16</sup>. Other schemes may emerge, so the sensor control circuits and antennas need to be able to accommodate these schemes for sensitive information and controls.

## 7. OPTICAL INTERCONNECT TECHNOLOGY

### 7.1. DIFFICULT CHALLENGES

Optical interconnect challenges are identified in [Table OSC1](#) and described in detail in section 3.2.

### 7.2. POTENTIAL NEAR TERM SOLUTIONS

#### 7.2.1 INTEGRATING TRANSMITTER COMPONENTS (DIRECT MODULATION)

Integrating signal conditioning, laser-driver and laser into a single package, Tables OSC4, OSC5 and OSC6. This can first be done by integrating individual components onto a 2D package, and later using 3D packaging stack the laser onto the signal conditioner with the laser driver. In the future, the signal conditioner and laser driver could be monolithically integrated.

For devices with modulation, the modulator could be integrated in the same package with the signal conditioner, driver, and laser. The laser would need to be aligned with waveguides for the modulator and the modulator output to a fiber compatible coupling.

Integrating Transmitter Components (External or Secondary)

The first level of integration would be to integrate lasers, MUX, modulators and couplers into a package. Critical issues are to reduce the size of the MUX and modulators, increase modulator operating frequency and reduce energy dissipation.

At the second level of integration, the MUX and modulators would be integrated onto one substrate (i.e. silicon, etc.) and then integrated into the package.

##### 7.2.1.1. INTEGRATING RECEIVER COMPONENTS

The first level of integration would be integrating the photodetector, amplifier and signal conditioner on a planar package. At the second level, 3D packaging would be employed to integrate the photodetector on the amplifier and signal conditioner into a smaller package. At the third level, the amplifier and signal conditioner could be integrated onto a single piece of silicon and then packaged with the detector on top.

##### 7.2.1.2. INTEGRATED TRANSMITTER/RECEIVER (SILICON PHOTONICS)

At the first level, optical modulator and photodetector are integrated on Silicon, while using 3D micro-pillar assembly to connect the modulator driver and detector amplifier to the photonic chip. The laser is also package and attached<sup>17</sup> on the photonic-chip. At the second level, the signal conditioner for the modulator and detector would be integrated onto one piece of silicon photonics together with the laser, and the modulator driver and detector amplifier. At the third level, the laser will be integrated monolithically on the silicon interposer chip.

##### 7.2.1.3. MONOLITHICALLY INTEGRATED LASER

Monolithic integration of the laser source into the silicon photonics chip is one of the main technological challenges to be addressed at the industrial level. Indeed, Si is a poor light emitter, which makes the use of direct band gap material for building the light source mandatory. III-V compounds are the most commonly used materials for fabricating infrared light sources. Unfortunately, their strong lattice and thermal expansion coefficient mismatch with Si makes their direct growth on SOI wafer incompatible with an industrial process. Nevertheless, the recent development SiO<sub>2</sub>-SiO<sub>2</sub> direct bonding made possible die to wafer III-V on silicon heterogeneous integration. The approach used to build integrated laser consist in using the silicon wafer to fabricate the laser cavity<sup>18, 19</sup> and to bond on its top an InGaAsP-based layer as the optical gain medium. An optimized co-design of both Si and III-V layer, based on the coupled mode theory, allows maximizing the optical coupling between the silicon cavity and the InGaAsP gain layers and obtaining low threshold electrically pumped infrared lasers.

### 7.2.2. INDIRECT MODULATION

For optical interconnects to meet future requirements, all supporting devices must operate with higher performance, lower energy consumption, higher optical efficiency, and have lower cost. Electro-optic modulators (EOM) can modulate the amplitude, phase, frequency, or polarization of the light; however, these devices must become more compact, operate with lower power consumption.

Several physical mechanisms can be used in order to generate a modulation of amplitude on the optical signal. The first possibility is to use an Electro-Absorption effect allowing the modification of the imaginary part of the optical index, and therefore a direct modification of the signal amplitude. The second possibility is to rely on Electro-Refractive effect, allowing the modification of the real part of the optical index, and thus leading to phase modulation. In conjunction with a Mach-Zehnder interferometer, this will create the modulation of the signal amplitude.

### **7.2.2.1. HIGHER DENSITY LOWER POWER MODULATORS**

#### **7.2.2.1.1 MACH ZEHNDER**

Mach Zehnders are interferometers that electrically modulate the dielectric constant of material in one path. Since the refractive index of most electroactive materials can only be changed a small amount, their length is on the order of ~5mm. This results in a significant capacitance which limits the operating frequency and makes reducing energy dissipation difficult.

The only way to reduce the active optical path is to identify new materials that have a higher electro-optic coefficient or new device structures that enable a higher effective electro-optic coefficient. Potential materials include: poled electro-optic polymers<sup>20</sup>, polymer-inorganic hybrids<sup>21,22</sup>, and co-polymers<sup>23</sup>. Poled electro-optic polymers have r<sub>33</sub> coefficients as high as 500pm/V with projections as high as 1000pm/V<sup>20</sup>. A 1mm long hybrid organic-silicon Mach Zehnder modulator operated at femto-Joule energy consumption with data rates of 40Gb/s and an electro-optic coefficient of ~180pm/V<sup>21</sup>.

To reduce the physical size of the inactive regions, emerging technologies including aperiodic nanophotonic structures and plasmonic routing structures should be investigated.

#### **7.2.2.1.2. RING MODULATORS**

Ring modulators have been demonstrated to effectively modulate the intensity of light with a small (~12μm) ring waveguide, with electrically modulated carrier density with a PIN diode structure, located in close proximity to a waveguide<sup>24</sup>. These modulators are dramatically smaller than Mach-Zehnder modulators and are very energy efficient. Cascading ring modulators that are each tuned to different wavelengths has demonstrated wavelength division modulation multiplexing (WDM) in a compact space<sup>25</sup>. The ring modulators have also been fabricated with electronic integrated circuits<sup>26</sup> which enables integration of the driver circuitry with potential for WDM.

## **7.3. POTENTIAL LONG TERM SOLUTIONS**

### **7.3.1. HIGH EFFICIENCY HIGH BANDWIDTH COMPONENTS**

To reduce energy dissipation and increase optical output, it is important to investigate new structures and devices that could lase at lower threshold currents, reduce capacitance.

#### **7.3.1.1. LASERS**

##### **7.3.1.1.1. MONOLITHICALLY INTEGRATED GROUP IV LASERS**

Germanium or other group IV based lasers offer the potential for integration on silicon wafers with conventional processing. Research on materials and devices enabling the full monolithic integration of LEDs/LASERS on silicon/CMOS substrates continues, through multiple approaches. Group-IV materials are still generally perceived as offering the easiest integration with CMOS technology, and significant research is underway to find direct band-gaps with large oscillator strengths. Engineering of strain, composition, dimensionality, structural order and symmetry, are all being employed to discover/generate modified band structures and optoelectronic properties. While germanium is an indirect bandgap semiconductor with a bandgap of 0.6eV, Ge on silicon under tensile strain doped n-type has been demonstrated to lase at room temperature<sup>27</sup> and devices were demonstrated to lase with electrical current injection<sup>28</sup> at room temperature. Modeling predicts that Ge<sub>1-x</sub>Sn<sub>x</sub> becomes direct bandgap with x>6.55%<sup>29</sup> and a Ge-Sn alloy has been demonstrated to produce materials and devices that lase<sup>30</sup> at temperatures <90K. Other approaches to enable modified band structures with direct gaps include theoretical predictions of direct band-gaps for CSiGeSn alloys<sup>31</sup>, and Si-Ge-C superlattices<sup>32</sup>, fabrication of hexagonal Silicon<sup>33</sup>, and theoretical studies and experimental demonstration of 2D group-IV materials: Silicene<sup>34</sup>, Germanene<sup>35</sup>, Stanene<sup>36</sup>. Thus, group IV materials with band structure modified by strain, alloy composition, nanostructure, or superlattice structure may enable lasers to be integrated on silicon with conventional processing.

##### **7.3.1.1.2. MONOLITHICALLY INTEGRATED III-V LASERS ON SILICON**

With research being performed to integrate III-V MOSFETs on silicon<sup>37,38</sup>, this could enable co-integration of III-V lasers on silicon. While many lasers are of multiple micron dimensions, a 250nm nanoscale plasmonic III-V laser has been

integrated on silicon<sup>39</sup> and generates milliwatts of optical power at ~100GHz. While this laser was intended for use with on chip optical interconnects, it could operate to communicate off chip.

### **7.3.1.1.3. NOVEL NANOSTRUCTURED LASERS**

An emerging technique to increase photonic light source energy dissipation is to introduce nanostructures that increase energy density. This has been used to demonstrate electrically pumped lasers with lasing thresholds of 287 nA at 150K<sup>40</sup> which is 1000X less than earlier electrically pumped nanocavity lasers. Furthermore, these structures have been used to demonstrate directly modulated photonic crystal nanocavity light-emitting diode (LED) with 10 GHz modulation speed and less than 1 fJ per bit energy of operation<sup>41</sup>. These demonstrate that nanostructured nanocavity lasers and LEDs have the potential to provide more energy efficient photonic sources for optical interconnects; however, the lasers must operate with high energy efficiency above room temperature.

The ability of lasers to controllably emit specific modes could enable compact optical circuits with new functionality. single mode ring laser<sup>42</sup> utilizing the parity-time symmetry breaking has been demonstrated that is intrinsically stable for a specific mode rather than having multiple competing modes. This capability could enable compact lasers and resonators that could enable on chip input/output with single modes of light. Furthermore, it is possible this principle could be used to control at will specific single modes that are emitted by the laser.

### **7.3.1.2. MODULATORS**

For optical interconnects to meet future requirements, all supporting devices must operate with higher performance, lower energy consumption, higher optical efficiency, and have lower cost. Electro-optic modulators (EOM) can modulate the amplitude, phase, frequency, or polarization of the light; however, these devices must become more compact, operate with lower power consumption.

Initial Mach-Zehnder interferometers were large and consumed significant power in modulating the light; however, newer compact devices have been demonstrated that require lower power and some may enable integration on substrates with lasers. A 100 $\mu$ m long silicon p-i-n diode Mach-Zehnder<sup>43</sup> has been demonstrated to modulate phase with 5pJ/bit.

A silicon lateral p-i-n ring diode less than 20 $\mu$ m diameter has been demonstrated to modulate wavelength<sup>44</sup> and could be used for wavelength division multiplexing (WDM). Incorporation of a photonic crystal into the silicon p-i-n diode structure<sup>45</sup> reduced power consumption with wavelength modulation. A reverse biased silicon p-n ring diode structure<sup>46</sup> was able to operate at 11GHz with energy consumption of 50fJ/bit and a device area of ~1000 $\mu$ m<sup>2</sup>. A GaAs photonic crystal cavity EOM<sup>47</sup> has been demonstrated that has the potential for sub fJ/bit energy consumption in the GHz frequency range.

Although these devices have dramatically reduced EOM size and energy consumption, modeling indicates the possibility for further improvement in energy consumption<sup>48</sup>.

### **7.3.1.2.3. ELECTRO ABSORPTION MODULATORS**

The most important issues for electroabsorption modulators are to have a high on/off ratio, be compact, have a high operating frequency, low optical loss, and low energy dissipation.

#### **7.3.1.2.3.1. BULK SEMICONDUCTOR FRANZ-KELDYSH EFFECT (III-V, Ge)**

When a high electric field is applied to a semiconductor, the absorption edge of the material can shift and absorption can increase. Application of an electric field causes a gradient in the valence and conduction bands of semiconductors and which increases tunneling and an overlap of wave functions which produces an increase of optical absorption near the bandgap. Thus, application of an electric field increases optical absorption near the bandgap. This must be done in a thin film to achieve significant tunneling between bands. This effect is most pronounced in direct bandgap semiconductors (i.e. III-V, Ge, GeSi).

A SiGe modulator on SOI has been demonstrated to operate at 28 Gb/s with 5.9dB on/off ratio at 3.0V bias with a 50  $\mu$ m long active region<sup>49</sup>. Work is needed to reduce the size, reduce voltage and reduce energy dissipation.

#### **7.3.1.2.3.2. PLASMONIC MACH ZEHNDER**

Recently, a plasmonic modulator that fits into a 10 $\mu$ m silicon waveguide has been demonstrated that operates to 70GHz and consumes 25fJ/bit<sup>50</sup>. This technology should be investigated to determine if performance can be further enhanced and characterize performance further.

#### **7.3.1.2.3.3. STARK EFFECT**

The Stark effect in semiconductor quantum wells occurs when coupled electron-hole pairs (Excitons) are trapped in quantum wells. This produces increased optical absorption near the bandgap of the quantum well bandgap. Application of an electric field reduces the overlap of the electron and hole wave functions and thus reduces the optical absorption near the bandgap. Thus, the Stark effect electro-absorption reduces light transmission without electric field and increases transmission with electric field. This effect has been demonstrated in Ge quantum wells<sup>51</sup>, a 90 $\mu\text{m}$  long Ge-SiGe quantum well modulator has been demonstrated to operate at 23Ghz with an on/off ratio of 9dB and energy dissipation of 108fJ/bit with a swing voltage of 1V between 3V and 4V<sup>52</sup>.

Further work should be done to increase the on/off ratio, reduce optical losses, reduce energy dissipation and determine the temperature dependence of modulation.

### **7.3.2. PASSIVE OPTICAL ELEMENTS**

#### **7.3.2.1. MULTIPLEXERS (MUX) AND DEMULTIPLEXERS (DEMUX)**

MUXes merge multiple wavelengths while DeMUXes separate wavelengths into separate waveguides or fibers. Currently, these devices must make gradual bends in the waveguide to maintain total internal reflection and minimize losses. As more wavelengths are merged into waveguides or fibers (i.e. 64, 128, 256, etc.) the size of these can become very large, so technologies are needed to enable low loss compact merging and splitting capabilities. Two potential approaches to this are aperiodic nanophotonic structures and plasmonic structures, which have the potential to compact wavelength merging functions to  $\mu\text{m}$  scale and thus significantly reduce the size of MUX and DeMUX devices. In particular, materials with optical index having a low thermal sensitivity will be required.

#### **7.3.2.2. Optical Isolators**

The ability to isolate optical devices, such as lasers, from light coming the wrong direction from a waveguide is important for achieving operational integrity. Optical isolators are currently large devices, but compact isolators are needed. Recently, an optical diode<sup>53</sup> with two 10 $\mu\text{m}$  diameter rings adjacent to waveguides has demonstrated with high transmission in the forward direction and 28dB exclusion in the reverse direction. This could enable optical isolators (diodes) to be integrated with lasers and eliminate stray signals from waveguides or fibers from introducing noise into the laser's operation.

#### **7.3.2.3. Mode Specific Resonators**

The ability of resonators controllably transmit or emit specific modes could enable compact optical circuits with new functionality. Recently, a coupled resonator based on parity-time symmetry breaking has been demonstrated that amplifies specific modes and absorb other modes in the "forward" direction<sup>54</sup>. This principle could be used to compactly control at will specific single modes that are emitted by the source.

#### **7.3.2.4. NANO PHOTONIC STRUCTURES**

New opportunities are emerging in optics for exploiting both multiple wavelengths and multiple spatial modes to allow us to continue to scale the information capacity of optical communications. These are enabled by a new generation of photonics that can be designed and customized to perform the exact function required. In turn, that photonics is physically enabled by emerging nanofabrication technologies, new complex nanophotonic structures, and by new fundamental understanding of optical components and design.

Additionally, advances in materials science and nanofabrication capabilities, combined with emerging new concepts in mesoscopic physics and quantum information theory are giving rise to a new field of study - quantum engineering. In essence, these developments in basic and applied science are creating new technological capabilities that could hardly have been foreseen during the formative years of electrical engineering. In order to facilitate the near-term realization of new quantum devices and systems, there is an immediate need to broaden the core analysis and design methodologies of electrical engineering to accommodate quantum substrates and quantum dynamical phenomena.

##### **7.3.2.4.1. APERIODIC NANOPHOTONIC STRUCTURES**

Future computing and communication systems require miniaturized components integrated into complex system for advanced information processing functionalities. The use of aperiodic and dynamic photonic structures may provide solutions to meet such requirements. In particular, the use of aperiodic structures enables the constructing of high density compact routing in waveguides with single wavelength scales. The use of dynamic structures potentially provides reconfigurability, as well as functionalities that are not available in static systems such as dynamic non-reciprocity.

Significant advances have been made in understanding the interactions of photons with aperiodic photonic structures. A particularly important advancement is the developments of ultra-fast numerical algorithms that enable fast simulations and optimization of nanophotonic structures<sup>55</sup>. With these algorithms it is possible to scan through very large ensemble of nanophotonic structures to develop a statistical understanding of these components in the presence of structural statistical variations, and to design highly functional and yet compact components for mode division multiplexing and wavelength division multiplexing systems.

For aperiodic nanophotonic structures, the temperature dependence of the structures and potential optical losses must be determined. Also, these structures would need to be encapsulated with a robust material of a different refractive index to protect the structures from contamination and environmental interferences.

### 7.3.2.4.1.1. INVERSE NANOPHOTONIC DESIGN AND IMPLEMENTATION

Remarkable progress has been made in optics (micro- and nano-photonics) over the past few decades, mostly focused around photonic crystals, quasi-crystals, and metamaterials. Despite such remarkable progress, all of the aforementioned structures are based on relatively simple geometries, consisting of regular shapes such as circles and rectangles, are periodic in two or three dimensions (photonic crystals and metamaterials) or in higher dimensions (quasi-crystals). They are constructed by repeating a simple unit cell in space (real 3D space for photonic crystals and metamaterials, or higher dimensional space for quasicrystals). Therefore, such materials span only a very limited set of the possible parameter space for optical structures, and it is extremely unlikely that optimal designs are in such a limited sub-space. In other words, most (if not all) of the optical structures we have ever studied are not optimal.

Computational nanophotonic methods (inverse design method) have been demonstrated, which are based on adapting the techniques of convex optimization to electromagnetics problems<sup>56</sup>. This approach potentially enables optimization of an optical device (structure) for a specific function without any restrictions on the parameter space. The optimized structures are free of any restrictions (such as periodicity in some number of dimensions or having to consist of regular shapes), except for constraints possibly imposed by the designer resulting from the experimental capabilities, such as fabrication tools and the set of available materials. This method can be used to design a structure that converts a desired input field to desired output fields. The researcher only identifies the desired input and output fields, conversion efficiencies, footprint, and any desired frequency dependence of the device characteristics. The researcher can also specify constraints on materials and feature sizes, if any. The algorithm starts with a black box and slowly converges (by spanning the full parameter space) towards a solution that exhibits the desired behavior. Therefore, the full parameter space can be explored in this process. The optimal structures designed using this method outperform conventional photonic structures, and the resulting designs are unique compared to earlier photonic structures, which have traditionally been designed by brute force parameter optimization and researcher intuition.

With this inverse design algorithm, a wide variety of linear waveguide-based nanophotonic devices have been designed and demonstrated including wavelength splitters, spatial mode multiplexers, TE/TM splitters, waveguide crossings, and fiber couplers<sup>53</sup>. These nanophotonic structures are fully three-dimensional and multi-modal, have very compact footprints (a few microns long at most), exhibit high efficiency, and are manufacturable. Several of these structures have been experimentally demonstrated<sup>57</sup>, showing that inverse designed structures can be fabricated and are robust to fabrication imperfections.

### 7.3.2.5. PLASMONIC STRUCTURES

There is a significant need for technologies that can compactly change the direction of light propagation and focus light on small features. Plasmonic structures have properties that could enable potential solutions to these issues<sup>58</sup>. Specific materials have surface electronic resonances that interact with photons and confine them in small waveguides (<100nm)<sup>59</sup>, and cause them to change directions in short distances<sup>59</sup>. An issue is that the plasmons absorb energy from the light at their resonance, so the interaction lengths must be short. Recently, it has been proposed to use electrical pumping to reduce losses in hybrid plasmonic waveguides<sup>60</sup>. On the other hand, the plasmons are relatively insensitive to temperature changes, so they should be stable with temperature.

Plasmonic structures have been predicted to enhance optical absorption in photodetectors<sup>61</sup>, confine light in sub wavelength waveguides, redirect light to new directions within 1  $\mu\text{m}$ . It has been predicted that novel structures may be able to significantly reduce losses in plasmonic waveguides<sup>62</sup>. The ability to concentrate light to very small photodetectors could enable very fast photodetectors with high signal to noise ratio<sup>63</sup>. It was proposed that plasmonics could be employed to produce energy efficient compact electromodulators<sup>64</sup> and an active plasmonic modulator has demonstrated 10Gb/s data rates with low energy<sup>65</sup>. Recently a 10 $\mu\text{m}$  plasmonic modulator has operated at 70GHz while consuming only 25fJ/bit<sup>66</sup>.

For future logic, a plasmonic absorber-amplifier<sup>67</sup> has been designed that could amplify specific wavelengths in a WDM application while absorbing other wavelengths, purify the phase of a non-phase pure source according to a phase-pure reference source, modulate an optical signal driven by an input gate optical signal with amplification, or provide directional optical isolation. Thus, plasmonics may not only have the potential for enabling compact dense photonic routing and modulation, but may also potentially enable photonic logic functions.

### 7.3.3. ELECTROOPTIC DYNAMIC OPTICAL ROUTING

Significant progress has been made in the study of dynamic photonic structures. Here, a particularly noteworthy development is the recognition that dynamic refractive index modulation can be used to break time reversal symmetry, leading to unidirectional optical components that reproduce the effects of standard magneto-optics, but with materials that are entirely CMOS-compatible<sup>68</sup>. It has been shown that the phase of dynamic modulation becomes a gauge field for photons that provides tremendous flexibility for the control of flow of light<sup>69,70</sup>.

To enable compact dynamic photonic devices, research is needed to identify materials that have a large modulation of dielectric constant with a short switching time. Furthermore, to enable optically based switching and routing, it is important to identify materials that have a large change in dielectric constant upon exposure to a specific wavelength of illumination. This would enable sending a switching wavelength over a fiber and changing the routing of the signal that has a different wavelength in the same fiber.

Analysis indicated that a silicon based micro-ring system can be used electrically route optical signals in a WDM environment<sup>71</sup>. It is also proposed that these devices can enable high bandwidth communication in Exascale computing environments if holistic approaches are used to optical device and system design<sup>72</sup>.

### 7.3.4. OPTICAL RECEIVERS AND AMPLIFIERS

A significant challenge for optical detectors is to increase operating frequency to support higher data rates. A limiting factor is the RC time constant of the photodetector. The most logical solution is to reduce the detector size which reduces junction capacitance, but this can increase resistance and may reduce coupling efficiency to the light from the waveguide. Effort would be needed to reduce the junction and contact resistance for the smaller photodetectors. If the detector intercepts less light from the waveguide, the amplifier will need to need higher gain which will potentially reduce the signal to noise ratio. The best solution to this is to develop techniques to effectively couple light from the waveguide into the detector. Possible solutions include using plasmonic structures above the photodetectors to focus light into the detector. Another option is to passive periodic or aperiodic nanophotonic structures to focus light onto the photodetector. The temperature dependence of the potential solutions needs to be understood, to design the optimal solution. This would give the amplifier a larger signal to amplify and reduce signal to noise.

### 7.3.5. OPTICALLY BASED SWITCHING AND ROUTING

Currently, optical signals are redirected by electrical routers where the light must be converted to electrical signals that are routed to different laser-fibers. This significant latency can be added to the transmission of optical signals that go through multiple routers. New technologies are needed to enable optically based switching and routing that doesn't require the optical-electrical-optical conversion. To support this, new materials and device structures are needed to enable this dynamic optically controlled routing capability. Potential schemes for driving may include having one wavelength dedicated to establishing the routing path, while others would transmit the data.

Optically based switching has been demonstrated in III-V<sup>73,74</sup> and in silicon<sup>75</sup> based structures, with micro-ring resonators, where sending a higher than bandgap photon pulse excites carriers and temporarily changes the refractive index of the material. These are examples of devices that could be integrated to enable optically based switching and routing functions. More research is needed to identify new technologies that offer greater flexibility in optically based switching and routing with lower power consumption.

### 7.3.6. OPTICALLY BASED LOGIC

If all optical networks are to be viable, optically based logic will be needed to identify signal stream routing conflicts and determine the correct routing alternative. A number of optical logic devices and functions have been proposed that require local nonlinearity of optical properties<sup>76</sup>. It is proposed that branched waveguides with local nonlinear optical materials could function as AND or OR functions<sup>77</sup>. All optical logic based on optical polarization switches has also been proposed<sup>75</sup> that would require polarizing switches that require optically activated polarizers<sup>78</sup>. Using cross gain modulation and cross phase modulation in semiconductor devices, many logic functions have been demonstrated including AND, OR, XOR, NOR and XNOR<sup>79</sup>, but they are limited to ~10Gb/s. Several all optical logic concepts have been proposed and some demonstrated, but their speed and efficiency would need to improve to support future all optical

networks. A critical need for all optical high speed logic is materials that can change optical properties at >100GHz speed upon exposure to optical signals.

### 7.4. TECHNOLOGY NEEDS

#### 7.4.1. DEVICE NEEDS

In the near term, high performance lasers and detectors must be developed to meet increasing data rate requirements and will be developed in arrays, such as VCSELs and compact detector arrays. In the future, there will be a need to integrate these onto silicon CMOS to provide high data rate I/O for logic and integrated circuits. The integration of the optical I/O onto silicon will place increased requirements on the III-V materials grown on silicon to reduce dislocations and other defects.

In the longer term, new optical devices are needed to provide dense optical routing and switching capabilities and enable totally optical routing networks. This will require development of novel logic devices that are optically switched at >100GHz to provide high speed routing within data centers and other large LAN facilities.

#### 7.4.2. MATERIAL NEEDS

In the near term, materials are needed that have a higher electro-optic coefficient (i.e. higher change of refractive index with application of voltage) to enable more compact Mach-Zehnder switches that operate at lower power. Also, optical waveguides are needed that enable low loss compact routing of light and plasmonic structures and aperiodic nanophotonic structures should be investigated.

Longer term, materials are needed whose optical properties (reflectivity or absorption) can be switched very rapidly with exposure to photons of a specific polarization or wavelength to enable optical logic to reduce network latency. These could be used in conjunction with aperiodic nanophotonic structures or plasmonic structures. The optical properties need to be switchable at >100GHz frequencies.

#### 7.4.3. HETEROGENEOUS INTEGRATION

In the near term, optical devices including lasers, detectors, waveguides, MUXes, deMUXes, modulators and supporting circuits will be integrated onto boards, cards, and then into packages. Each of these devices have requirements or control of stress, temperature, and electrical isolation, so new interface materials and assembly processes will be needed to manage these complex requirements. Furthermore, as the optical signals come to the edge of the board, card or package, connectors will be needed that couple the output to multimode or single mode fibers with low coupling loss. For detailed description of packaging issues and potential solutions, see the ITRS Heterogeneous Integration Chapter.

#### 7.4.4. TEST, INSPECTION, MEASUREMENT (TIM) FOR OPTICAL SIGNALS

The most demanding test requirements are found in single mode applications so those are emphasized in Table OSC14. Multimode signal testing is usually less demanding.

##### Table OSC14: Optical Interconnect Test Capability Requirements

The Telecom Industry utilizes single mode technology over hundreds of kilometers and has led the development of optical test equipment and capability. Much of that equipment can be adopted for use with products being developed for the emerging shorter distance applications.

Data communications products are being built in high volume (millions of transceivers and Active Optical Cables per year) and their test needs differ from Telecom in that they tend to utilize more parallel signal transmission through parallel media, either ribbon fiber or waveguide arrays, transmit light shorter distances and hence are not impacted as much by dispersion impediments and sometimes utilize more complex modulation schemes.

Test time and the related cost is an important issue for optical products.

In many cases, optical products generate their own light signal and testing requires only evaluating the resulting signals. Some products require light to be injected in them to evaluate their properties. The need to inject light signals is most common for in-process testing or evaluation of subassemblies.

While Traditional telecom products were often built with fiber pigtails approximately 1 meter long, Datacom products usually utilize an industry standard connector. In principle, these connectors can be used as test interfaces. As a practical matter they tend to have a limited life and limited number of cycles. That may be an issue the test community needs to address.



The general optical signal technical properties and test parameters follow in the table below. Also, for detailed description of optical component testing challenges and potential solutions, see the ITRS Heterogeneous Integration Chapter testing section.

#### **7.4.5. WAFER LEVEL MEASUREMENT (PROBING)**

In future technologies, the I/O may be integrated onto the CPU and this would require functional testing at wafer probing. At the wafer level, the optical source would need to be tested for power consumption, optical output levels, and the ability to modulate the signal (not necessarily at maximum frequency). Probe would also need to measure wavelength and possibly wavelength distribution, as shown in Table OSC14.

The tester will also need to be able to test small photodetectors for both leakage current and photocurrent at the required wavelength. In the case where the amplifier and signal conditioner are integrated with the photodetector, the on/off ratio output by the amplifier/conditioner needs to be measured.

#### **Table OSC14. Optical Interconnect Test Capability Requirements**

#### **7.4.6. TESTING PACKAGED LOGIC WITH OPTICAL I/O**

Initial testing of the packaged optical interconnects could be performed by feeding the output back into the input with an optical fixture/pigtail, as shown in table OSC14. Detailed functional testing of logic, memory interface chips, and other optical logic need to be tested at operating speed and over a range of temperatures, so the test fixture must have light sources and photodetectors that can operate at the required data rate. The light source and detector could be remote with fiber or waveguide transport to the optical ports on the test fixture. The test fixture would need to operate at the temperature extremes (low and high) with optical interfaces functioning.

#### **7.4.7. RELIABILITY**

As more optical interconnects are used to communicate between systems at high data rates, the reliability of components and the cost of maintaining a reliable network will become a bigger issue. As higher data rates are required, single mode communication will become more widely used and this is more sensitive to the entry location and angle of the light. So, while the output of components may not change dramatically, the shifts in the wavelength distribution or alignment of the light to the fiber could shift over time from the laser or modulators which could become a failure. Also, as more fibers are installed in high data rate applications, the failure of an optical interconnect can significantly impact the operation of a data center or LAN, so system level solutions need to be developed to address optical link failures.

##### **7.4.7.1. COMPONENT RELIABILITY**

As higher data rate optical interconnects are used, single mode communication with multiple wavelengths and polarizations per fiber will become more common. This will require highly reliable lasers, modulators, MUXes, and DeMUXes that couple effectively to single mode fibers. Thus, mechanisms that effect laser output, and the stability of wavelength distribution as a function of time must be understood and methods developed to improve these. In addition, the time dependence of modulator operation must be understood and methods developed to improve their functional reliability. As more devices are used to modulate the light, the reliability of individual components must dramatically improve to meet the overall reliability requirements for the optical link.

##### **7.4.7.2. SYSTEM LEVEL RELIABILITY**

With data rates increasing dramatically and many applications needing highly reliable communications within different networks, there is a need to develop a system level architecture that has built-in redundancy. Also, within rack components that support fast hot pluggable repairs.

#### **7.4.8. MODELING AND SIMULATION**

To support development of compact energy efficient optical routing elements, detailed models of aperiodic nanophotonic structures and plasmonic structures are needed to analyze and design potential optical elements<sup>46</sup>. To enable enhanced electro-optic switching, models are needed that can predict changes of refractive index in materials and heterostructures with application of an electric field and also predict electrical properties.

To enable research in materials that could enable optical logic and routing capabilities, models are needed to identify materials, heterostructures, superlattices, or metamaterials, whose optical properties (absorbance, reflectivity, etc.) at specific wavelengths can be dramatically changed with exposure to a different wavelength or polarizations of light. These models need to be able to predict the switching energy and time constant for switching.

## 8. SUMMARY

RF communication is expected to have an ever increasing role in wireless communications between a wide range of devices and the internet. To support this, a higher performance lower power RF and analog devices will be needed to support these diverse applications. Furthermore, optical communications will have an ever increasing role in supporting high bandwidth communications within the internet and within some mobile systems. Thus, new devices will be needed to enable compact low power routing of optical signals within these systems and data centers. With increased communication of data over the internet, novel communication technologies and software are needed to dramatically increase security for a wide range of applications.

This first version of the Outside System Connectivity chapter is limited in scope and invites input from application users and component and system manufacturers for future revisions.

## 9. REFERENCES

- [1] Principles of LED Light Communication Toward Networked Li-Fi. S. Dimitrov and H. Haas. Cambridge University Press, Cambridge CB2 8BS, United Kingdom, (2015). ISBN: [9781107049420](#).
- [2] A. Gomez, K. Shi, C. Quintana, M. Sato, G. Faulkner, B. C. Thomsen, and D. O'Brien. "Beyond 100-Gb/s Indoor Wide Field-of-View Optical Wireless Communications". *IEEE Photonics Tech. Lett.* **27**, pp.367-370, (2015). DOI: [10.1109/LPT.2014.2374995](#).
- [3] White Paper - Cisco Global Cloud Index: Forecast and Methodology, 2013–2018: [http://www.cisco.com/c/en/us/solutions/collateral/service-provider/global-cloud-index-ci/Cloud\\_Index\\_White\\_Paper.html](http://www.cisco.com/c/en/us/solutions/collateral/service-provider/global-cloud-index-ci/Cloud_Index_White_Paper.html)
- [4] K. Wang, A. Nirmalathas, C. Lim, E. Skafidas, and K. Alameh. "Performance of High-Speed Reconfigurable Free-Space Card-to-Card Optical Interconnects Under Air Turbulence". *J. of Lightwave Tech.* **31**, pp. 1687-1693, (2013). DOI: [10.1109/JLT.2013.2256459](#).
- [5] E. Chan. "Wireless Optical Links for Airplane Applications", *Photonics Society Summer Topical Meeting Series, IEEE 09 Jul - 11 Jul 2012 Seattle, WA, USA*, pp. 76–77, (2012). DOI: [10.1109/PHOSST.2012.6280709](#).
- [6] D. Marinos, C. Aidinis, N. Schmitt, J. Klaue, J. Schalk, T. Pistner, P. Kouros. "Wireless optical OFDM implementation for aircraft cabin communication links". *5th International Symposium on Wireless Pervasive Computing (ISWPC)*, (2010). DOI: [10.1109/ISWPC.2010.5483801](#).
- [7] E. Chan, D. Koshinz, W. Krug, and H. Hager. "Wireless optical links for avionics applications". *Proc. SPIE 8026, Photonic Applications for Aerospace, Transportation, and Harsh Environment II, 80260M* (2011). DOI: [10.1117/12.886858](#).
- [8] <http://standards.ieee.org/news/2014/ieeesa-mig-collaborate-ehealth-iot.html>
- [9] <http://www.inemi.org/project-page/qualification-methods-portable-medical-products-0>
- [10] <http://www.inemi.org/project-page/defining-requirements-development-medical-electronics-reliability-specifications>
- [11] <http://www.inemi.org/node/2456>
- [12] O. O. Koyluoglu, H. El Gamal, L. Lai, and H. V. Poor. "Interference Alignment for Secrecy". *IEEE Trans. on Information Theory* **57**, pp. 3323-3332, (2011). DOI: [10.1109/TIT.2011.2132430](#).
- [13] X. Chen, C. Zhong, C. Yuen, and H.-H. Chen. "Multi-Antenna Relay Aided Wireless Physical Layer Security". [arXiv:1504.02980v1](#), (2015).
- [14] N. Anand, S.-J. Lee and E. W. Knightly. "STROBE: Actively Securing Wireless Communications using Zero-Forcing Beamforming". *INFOCOM, Proceedings IEEE*, pp. 720 – 728, (2012), Orlando, FL. DOI: [10.1109/INFOCOM.2012.6195817](#).
- [15] J. Y. Koh, J. C. Ming Teo, D. Leong, and W.-C. Wong. "Reliable Privacy-Preserving Communications for Wireless Ad Hoc Networks". *IEEE International Conference on Communications*, June 8-12, (2015), London, UK. PDF: <http://www1.i2r.a-star.edu.sg/~dleong/pub/2015-ICC-Privacy-KTLW.pdf>.
- [16] F. Yavuz, J. Zhao, O. Yağan, and V. Gligor. "Designing secure and reliable wireless sensor networks under a pairwise key predistribution scheme". *IEEE International Conference on Communications*, June 8-12, (2015), London, UK. PDF: [http://www.contrib.andrew.cmu.edu/~oyagan/Conferences/ICC\\_2015.pdf](http://www.contrib.andrew.cmu.edu/~oyagan/Conferences/ICC_2015.pdf).
- [17] F. Boeuf, S. Cremer, E. Temporiti, M. Fere, M. Shaw, N. Vulliet, B. Orlando, D. Ristoiu, A. Farcy, T. Pinguet, A. Mekis, G. Masini, P. Sun, Y. Chi, H. Petiton, S. Jan, J. R. Manouvrier, C. Baudot, P. Le Maitre, J.-F. Carpentier, L. Salager, M. Traldi, L. Maggi, D. Rigamonti, C. Zaccherini, C. Elemi, B. Sautreuil, and L. Verga, "Recent progress in Silicon Photonics R & D and manufacturing on 300mm wafer platform". *Optical Fiber Communications Conference and Exhibition (OFC)*, 2015, pp. 1–3, (2015), DOI: <http://dx.doi.org/10.1364/OFC.2015.W3A.1>.
- [18] B. Ben Bakir, A. Descos, N. Olivier, D. Bordel, P. Grosse, E. Augendre, L. Fulbert, and J. M. Fedeli, "Electrically driven hybrid Si/III-V Fabry-Pérot lasers based on adiabatic mode transformers". *Optics Express* **19**, pp. 10317-10325, (2011), DOI: [10.1364/OE.19.010317](#).

- [19] A. W. Fang, H. Park, O. Cohen, R. Jones, M. J. Paniccia, and J. E. Bowers. “Electrically pumped hybrid AlGaInAs-silicon evanescent laser”. *Opt. Express* 14, 9203, (2006). DOI: <http://dx.doi.org/10.1364/OE.14.009203>.
- [20] L. R. Dalton, P. A. Sullivan, and D. H. Bale. “Electric Field Poled Organic Electro-optic Materials: State of the Art and Future Prospects”. *Chem. Rev.* **110**, pp. 25–55, (2010). DOI: [10.1021/cr9000429](https://doi.org/10.1021/cr9000429).
- [21] S. Koeber, R. Palmer, M. Lauermann, W. Heni, D. L. Elder, D. Korn, M. Woessner, L. Alloatti, S. Koenig, P. C. Schindler, H. Yu, W. Bogaerts, L. R. Dalton, W. Freude, J. Leuthold, and C. Koos. “Femtojoule electro-optic modulation using a silicon–organic hybrid device”. *Light: Science & Applications* **4**, pp. e255, (2015). DOI: [10.1038/lsa.2015.28](https://doi.org/10.1038/lsa.2015.28).
- [22] Y. Enami, D. Mathine, C. T. DeRose, R. A. Norwood, J. Luo, A. K.-Y. Jen, and N. Peyghambarian. “Transversely tapered hybrid electro-optic polymer/sol-gel Mach–Zehnder waveguide modulators”. *Appl. Phys. Lett.* **92**, pp. 193508, (2008). DOI: [10.1063/1.2927489](https://doi.org/10.1063/1.2927489).
- [23] S. Michel, J. Zyss, I. Ledoux-Rak, and C. T. Nguyen. “High-performance electro-optic modulators realized with a commercial side-chain DR1-PMMA electro-optic copolymer”. *Proceedings of SPIE* **7599**, 759901, (2010). DOI: [10.1117/12.841339](https://doi.org/10.1117/12.841339).
- [24] Q. Xu, B. Schmidt, S. Pradhan, and M. Lipson. “Micrometre-scale silicon electro-optic modulator”. *Nature* 435, pp. 325-327, (2005). DOI: [10.1038/nature03569](https://doi.org/10.1038/nature03569).
- [25] Q. Xu, B. Schmidt, J. Shakya, and M. Lipson. “Cascaded silicon micro-ring modulators for WDM optical interconnection”. *Optics Express* **14**, pp. 9430-9435, (2006). DOI: [10.1364/OE.14.009431](https://doi.org/10.1364/OE.14.009431).
- [26] J. S. Orcutt, A. Khilo, M. A. Popović, C. W. Holzwarth, B. Moss, H. Li, M. S. Dahlem, T. D. Bonifield, F. X. Kärtner, E. P. Ippen, J. L. Hoyt, R. J. Ram and V. Stojanović. “Demonstration of an Electronic Photonic Integrated Circuit in a Commercial Scaled Bulk CMOS Process”. *CLEO/QELS* (2008), ISBN: 978-1-55752-859-9.
- [27] J. Liu, X. Sun, R. Camacho-Aguilera, L. C. Kimerling, and J. Michel. “Ge-on-Si laser operating at room temperature”. *Optics Letters* 35, pp. 679-681, (2010), DOI: [10.1364/OL.35.000679](https://doi.org/10.1364/OL.35.000679).
- [28] R. E. Camacho-Aguilera, Y. Cai, N. Patel, J. T. Bessette, M. Romagnoli, L. C. Kimerling, and J. Michel. “An electrically pumped germanium laser”. *Optics Express* 20, pp. 11316-11320, (2012). DOI: [10.1364/OE.20.011316](https://doi.org/10.1364/OE.20.011316).
- [29] B. Dutt, H. Lin, D. S. Sukhdeo, B. M. Vulovic, S. Gupta, D. Nam, K. C. Saraswat, Fellow, and J. S. Harris Jr. “Theoretical Analysis of GeSn Alloys as a Gain Medium for a Si-Compatible Laser”. *IEEE J. of Selected Topics in Quantum Electronics*, 19, pp. 1502706, (2013). DOI: [10.1109/JSTQE.2013.2241397](https://doi.org/10.1109/JSTQE.2013.2241397).
- [30] S. Wirths, R. Geiger, N. von den Driesch, G. Mussler, T. Stoica, S. Mantl, Z. Ikonic, M. Luysberg, S. Chiussi, J. M. Hartmann, H. Sigg, J. Faist, D. Buca and D. Grützmacher. “Lasing in direct-bandgap GeSn alloy grown on Si”. *Nature Photonics* 19, pp. 88-92, (2015). DOI: [10.1038/nphoton.2014.321](https://doi.org/10.1038/nphoton.2014.321).
- [31] R. Soref. "Direct-bandgap compositions of the CSiGeSn group-IV alloy." *Opt. Mater. Express* **4**, pp. 836-842 (2014), DOI: [10.1364/OME.4.000836](https://doi.org/10.1364/OME.4.000836).
- [32] C. J. R. P. Augusto and L. Forester. “Novel Si-Ge-C Superlattices and Their Applications.” Volume 110, August 2015, Pages 1–9, Selected papers from the 7th International SiGe Technology and Device Meeting (ISTDM 2014), DOI: [10.1016/j.sse.2015.01.019](https://doi.org/10.1016/j.sse.2015.01.019).
- [33] H. Ikaros, T. Hauge, M. A. Verheijen, S. Conesa-Boj, T. Etzelstorfer, M. Watzinger, D. Kriegner, I. Zardo, C. Fasolato, F. Capitani, P. Postorino, S. Kölling, A. Li, S. Assali, J. Stangl, and E. P. A. M. Bakkers. “Hexagonal Silicon Realized”. *Nano Letters Article ASAP*, DOI: [10.1021/acs.nanolett.5b01939](https://doi.org/10.1021/acs.nanolett.5b01939).
- [34] H. Liu, J. Gao and J. Zhao. “Silicene on Substrates: A Way To Preserve or Tune Its Electronic Properties”. *The Journal of Physical Chemistry C* **117**, pp. 10353-10359, (2013). DOI: [10.1021/jp311836m](https://doi.org/10.1021/jp311836m).
- [35] A. Nijamudheen, R. Bhattacharjee, S. Choudhury, and A. Datta. “Electronic and Chemical Properties of Germanene: The Crucial Role of Buckling”. *J. Phys. Chem. C* **119**, pp 3802–3809, (2015). DOI: [10.1021/jp511488m](https://doi.org/10.1021/jp511488m).
- [36] F.-f. Zhu, W.-j. Chen, Y. Xu, C.-l. Gao, D.-d. Guan, C.-h. Liu, D. Qian, S.-C. Zhang, and J.-f. Jia. “Epitaxial growth of two-dimensional stanene”. *Nature Materials* (2015) DOI: [10.1038/nmat4384](https://doi.org/10.1038/nmat4384).
- [37] M. Radosavljevic, B. Chu-Kung, S. Corcoran, G. Dewey, M. K. Hudait, J. M. Fastenau, J. Kavalieros, W. K. Liu, D. Lubyshev, M. Metz, K. Millard, N. Mukherjee, W. Rachmady, U. Shah, and R. Chau. “Advanced High-K Gate

- Dielectric for High-Performance Short-Channel In<sub>0.7</sub>Ga<sub>0.3</sub>As Quantum Well Field Effect Transistors on Silicon Substrate for Low Power Logic Applications.” *IEEE Int. Electron. Dev. Meet.* **2013**, 13.1.1 (2013).
- [38] Y. Sun, *et al.* High-Performance CMOS-Compatible Self-Aligned In<sub>0.53</sub>Ga<sub>0.47</sub>As MOSFETs with GMSAT over 2200  $\mu$  S/ $\mu$  m at VDD = 0.5 V. *IEEE Int. Electron. Dev. Meet.* **2014**, 25.3.1 (2014).
- [39] N. Li, K. Liu, V. J. Sorger, and D. K. Sadana. “Monolithic III–V on Silicon Plasmonic Nanolaser Structure for Optical Interconnects.” *Nature Scientific Reports* **5**, 14067, 2015.
- [40] B. Ellis, M. Mayer, G. Shambat, T. Sarmiento, E. Haller, J. S. Harris, and J. Vuckovic. “Ultralow-threshold electrically pumped quantum-dot photonic-crystal nanocavity laser”. *Nature Photonics* **5**, pp. 297-300 (2011). DOI: [10.1038/nphoton.2011.51](https://doi.org/10.1038/nphoton.2011.51).
- [41] G. Shambat, B. Ellis, A. Majumdar, J. Petykiewicz, M. A. Mayer, T. Sarmiento, J. Harris, E. E. Haller and J. Vuckovic. “Ultrafast direct modulation of a single-mode photonic crystal nanocavity light-emitting diode”. *Nature Communications* **2**, 593 (2011). DOI: [10.1038/ncomms1543](https://doi.org/10.1038/ncomms1543).
- [42] L. Feng, Z. Jing Wong, R.-M. Ma, Y. Wang, and X. Zhang. “Single-mode laser by parity-time symmetry breaking.” *Science* **346**, pp. 972-975, (2014). DOI: [10.1126/science.1258479](https://doi.org/10.1126/science.1258479).
- [43] W. M. Green, M. J. Rooks, L. Sekaric, and Y. A. Vlasov. “Ultra-compact, low RF power, 10 Gb/s silicon Mach-Zehnder modulator”. *Optics Express* **15**, pp. 17106–17113, (2007). DOI: [10.1364/OE.15.017106](https://doi.org/10.1364/OE.15.017106).
- [44] Q. Xu, B. Schmidt, S. Pradhan, and M. Lipson. “Micrometre-scale silicon electro-optic modulator”. *Nature* **435**(7040), 325–327 (2005). DOI: [10.1038/nature03569](https://doi.org/10.1038/nature03569).
- [45] T. Tanabe, K. Nishiguchi, E. Kuramochi, and M. Notomi. “Low power and fast electro-optic silicon modulator with lateral p-i-n embedded photonic crystal nanocavity”. *Opt. Express* **17**, pp. 22505–22513, (2009). DOI: [10.1364/OE.17.022505](https://doi.org/10.1364/OE.17.022505).
- [46] P. Dong, S. Liao, D. Feng, H. Liang, D. Zheng, R. Shafiiha, C.-C. Kung, W. Qian, G. Li, X. Zheng, A. V. Krishnamoorthy, and M. Asghari. “Low Vpp, ultralow-energy, compact, high-speed silicon electro-optic modulator”. *Optics Express* **17**, pp. 22484–22490, (2009). DOI: [10.1364/OE.17.022484](https://doi.org/10.1364/OE.17.022484).
- [47] G. Shambat, B. Ellis, M. Mayer, A. Majumdar, E. Haller, and J. Vuckovic. “Ultra-low power fiber-coupled gallium arsenide photonic crystal cavity electro-optic modulator”. *Optics Express*, **19**, pp. 7530-7536 (2011). DOI: [10.1364/OE.19.007530](https://doi.org/10.1364/OE.19.007530).
- [48] D.A.B. Miller. “Energy consumption in optical modulators for interconnects”. *Optics Express*. **20**, A293 (2012). DOI: [10.1364/OE.20.00A293](https://doi.org/10.1364/OE.20.00A293).
- [49] D. Feng, W. Qian, H. Liang, C.-C. Kung, Z. Zhou, Z. Li, J. S. Levy, R. Shafiiha, J. Fong, B. J. Luff, and M. Asghari. “High-Speed GeSi Electroabsorption Modulator on the SOI Waveguide Platform”. *IEEE J. of Selected Topics in Quantum Electronics* **19**, pp. 3401710, (2013). DOI: [10.1364/OE.20.022224](https://doi.org/10.1364/OE.20.022224).
- [50] C. Haffner, W. Heni, Y. Fedoryshyn, J. Niegemann, A. Melikyan, D. L. Elder, B. Baeuerle, Y. Salamin, A. Josten, U. Koch, C. Hoessbacher, F. Ducry, L. Juchli, A. Emboras, D. Hillerkuss, M. Kohl, L. R. Dalton, C. Hafner and J. Leuthold. “All-plasmonic Mach–Zehnder modulator enabling optical high-speed communication at the microscale”. *Nature Photonics* **9**, pp. 525-528 (2015). DOI: [10.1038/nphoton.2015.127](https://doi.org/10.1038/nphoton.2015.127).
- [51] Y.-H. Kuo, Y. K. Lee, Y. Ge, S. Ren, J. E. Roth, T. I. Kamins, D. A. B. Miller, and J. S. Harris. “Strong quantum-confined Stark effect in germanium quantum-well structures on silicon”. *Nature* **437**, pp. 1334-1336, (2005). DOI: [10.1038/nature04204](https://doi.org/10.1038/nature04204).
- [52] P. Chaisakul, D. Marris-Morini, M.-S. Rouified, G. Isella, D. Chrastina, J. Frigerio, X. Le Roux, S. Edmond, J.-R. Coudevylle, and L. Vivien. “23 GHz Ge/SiGe multiple quantum well electroabsorption modulator”. *Optics Express* **20**, pp. 3219, (2012). DOI: [10.1364/OE.20.003219](https://doi.org/10.1364/OE.20.003219).
- [53] L. Fan, J. Wang, L. T. Varghese, H. Shen, B. Niu, Y. Xuan, A. M. Weiner, and M. Qi. “An All-Silicon Passive Optical Diode.” *Science* **335**, pp. 447-450, (2012). DOI: [10.1126/science.1214383](https://doi.org/10.1126/science.1214383).
- [54] B. Peng, S. K. Özdemir, F. Lei, F. Monifi, M. Gianfreda, G. L. Long, S. Fan, F. Nori, C. M. Bender, and L. Yang. “Parity–time-symmetric whispering-gallery microcavities.” *Nature Physics* **10**, pp. 394-398, (2014). DOI: [10.1038/nphys2927](https://doi.org/10.1038/nphys2927).

- [55] V. Liu, D. A. B. Miller and S. Fan. “Application of computational electromagnetics for nanophotonics design and discovery”. *Proceedings of the IEEE*, vol. 101, no. 2, pp. 484-493 (2013). DOI: <http://dx.doi.org/10.1109/JPROC.2012.2207649>.
- [56] J. Lu and J. Vuckovic. “Nanophotonic computational design,” *Optics Express*, 21 (11), pp. 13351-13367 (2013). DOI: [10.1038/nphoton.2014.177](https://doi.org/10.1038/nphoton.2014.177).
- [57] A. Y. Piggott, J. Lu, T. M. Babinec, K. G. Lagoudakis, J. Petykiewicz, and J. Vuckovic, “Inverse design and implementation of a wavelength demultiplexing grating coupler”, *Scientific Reports* 4, 7210 (2014). DOI: [10.1038/srep07210](https://doi.org/10.1038/srep07210).
- [58] S. A. Maier, M. L. Brongersma, P. G. Kik, S. Meltzer, A. A. G. Requicha, and H. A. Atwater. “Plasmonics- A Route to Nanoscale Optical Devices”. *Adv. Mater.*, **13**, pp. 1501-1505, (2001). DOI: [10.1002/adma.200390134](https://doi.org/10.1002/adma.200390134).
- [59] G. Veronis, Z. Yu, S. E. Kocabas, D. A. B. Miller, M. L. Brongersma, and S. Fan. “Metal-dielectric-metal plasmonic waveguide devices for manipulating light at the nanoscale”. *Chinese Optics Letters*, **7**, pp. 302-308, (2009). PDF: <http://ee.stanford.edu/~dabm//373.pdf>.
- [60] D. A. Svintsov, A. V. Arsenin, and D. Yu. Fedyanin. “Full loss compensation in hybrid plasmonic waveguides under electrical pumping.” *Optics Express* 23, pp. 19359, (2015).
- [61] Z. Yu, G. Veronis, S. Fan, and M. L. Brongersma. “Design of midinfrared photodetectors enhanced by surface plasmons on grating structures”. *Applied Physics Letters* **89**, pp. 151116, (2006). DOI: [10.1063/1.2360896](https://doi.org/10.1063/1.2360896).
- [62] Z. Yu, G. Veronis, S. Fan, and M. L. Brongersma. “Gain-induced switching in metal-dielectric-metal plasmonic waveguides.” *Applied Physics Letters* **92**, pp. 041117, (2008).
- [63] J. A. Schuller, E. S. Barnard, W. Cai, Y. C. Jun, J. S. White and M. L. Brongersma. “Plasmonics for extreme light concentration and manipulation”. *Nature Materials* **9**, pp. 193-204, (2010). DOI: [10.1038/nmat2630](https://doi.org/10.1038/nmat2630).
- [64] W. Cai, J. S. White, and M. L. Brongersma. “Compact, High-Speed and Power-Efficient Electrooptic Plasmonic Modulators”. *Nano Lett.* **9**, pp. 4403-4411, 2009. DOI: [10.1021/nl902701b](https://doi.org/10.1021/nl902701b).
- [65] S. Papaioannou, D. Kalavrouziotis, K. Vysokinos, J.-C. Weeber, K. Hassan, L. Markey, A. Dereux, A. Kumar, S. I. Bozhevolnyi, M. Baus, T. Tekin, D. Apostolopoulos, H. Avramopoulos, and N. Pleros. “Active plasmonics in WDM traffic switching applications”. *Nature Scientific Reports* **2**, pp. 652, (2012). DOI: [10.1038/srep00652](https://doi.org/10.1038/srep00652).
- [66] C. Haffner, W. Heni, Y. Fedoryshyn, J. Niegemann, A. Melikyan, D. L. Elder, B. Baeuerle, Y. Salamin, A. Josten, U. Koch, C. Hoessbacher, F. Ducry, L. Juchli, A. Emboras, D. Hillerkuss, M. Kohl, L. R. Dalton, C. Hafner, and J. Leuthold. “All-plasmonic Mach-Zehnder modulator enabling optical high-speed communication at the microscale”. *Nature Photonics* **9**, pp. 525-529, (2015). DOI: [10.1038/nphoton.2015.127](https://doi.org/10.1038/nphoton.2015.127).
- [67] B. Baum, H. Alaeian, and J. Dionne. “A parity-time symmetric coherent plasmonic absorber-amplifier”. *J. Appl. Phys.* **117**, pp. 063106, (2015). DOI: [10.1063/1.4907871](https://doi.org/10.1063/1.4907871).
- [68] Z. Yu and S. Fan. “Complete optical isolation created by indirect interband photonic transitions”. *Nature Photonics*, vol. 3, pp. 91-94 (2009). DOI: <http://dx.doi.org/10.1038/nphoton.2008.273>.
- [69] K. Fang, Z. Yu and S. Fan. “Realizing effective magnetic field for photons by controlling the phase of dynamic modulation”. *Nature Photonics*, vol. 6, pp. 782-787 (2012). DOI: [10.1038/nphoton.2012.236](https://doi.org/10.1038/nphoton.2012.236).
- [70] L. Tzuang, K. Fang, P. Nussenzeig, S. Fan, and M. Lipson. “Non-reciprocal phase shift induced by an effective magnetic flux for light”. *Nature Photonics*, vol. 8, pp. 701-705 (2014). DOI: [10.1038/nphoton.2014.177](https://doi.org/10.1038/nphoton.2014.177).
- [71] D. Nikolova, S. Rumley, D. Calhoun, Q. Li, R. Hendry, P. Samadi, and K. Bergman. “Scaling silicon photonic switch fabrics for data center interconnection networks.” *Optics Express* 23, pp. 1160-1175, (2015).
- [72] S. Rumley, D. Nikolova, R. Hendry, Q. Li, D. Calhoun, and K. Bergman. “Silicon Photonics for Exascale Systems.” *J. of Lightwave Tech.* **33**, pp. 547-562. (2015).
- [73] V. Van, T. A. Ibrahim, K. Ritter, P. P. Absil, F. G. Johnson, R. Grover, J. Goldhar, and P.-T. Ho. “All-optical nonlinear switching in GaAs-AlGaAs microring resonators”. *IEEE Photon. Technol. Lett.* **14**, pp. 74-76 (2002). DOI: [10.1109/68.974166](https://doi.org/10.1109/68.974166).

- [74] T. A. Ibrahim, W. Cao, Y. Kim, J. Li, J. Goldhar, P.-T. Ho, and C. H. Lee. "All-optical switching in a laterally coupled microring resonator by carrier injection". IEEE Photon. Technol. Lett. **15**, pp. 36–38, (2003). DOI: [10.1109/LPT.2002.805877](https://doi.org/10.1109/LPT.2002.805877).
- [75] V. R. Almeida, C. A. Barrios, R. R. Panepucci, and M. Lipson. "All-optical control of light on a silicon chip". Nature **431**, pp. 1081-1084, (2004). DOI: <http://dx.doi.org/10.1038/nature02921>.
- [76] Y-D. Wu. "All-Optical Logic Gates by Using Multibranch Waveguide Structure With Localized Optical Nonlinearity". IEEE J. of Selected Topics in Quantum Electronics, **11**, pp. 307- 312, 2005. DOI: [10.1109/JSTQE.2005.846534](https://doi.org/10.1109/JSTQE.2005.846534).
- [77] J. H. Kim, Y. I. Kim, Y. T. Byun, Y. M. Jhon, S. Lee, S. H. Kim and D. H. Woo. "All-Optical Logic Gates Using Semiconductor Optical-Amplifier-Based Devices and Their Applications". J. of the Korean Physical Society **45**, pp. 1158 -1161, 2004. DOI: [10.1109/NUSOD.2003.1263226](https://doi.org/10.1109/NUSOD.2003.1263226).
- [78] Y. A. Zaghloul, A. R. M. Zaghloul, and A. Adibi. "Passive all-optical polarization switch, binary logic gates, and digital processor". Optics Express **19**, pp. 20335, 2011. DOI: [10.1364/OE.19.020332](https://doi.org/10.1364/OE.19.020332).
- [79] J. H. Kim, Y. I. Kim, Y. T. Byun, Y. M. Jhon, S. Lee, S. H. Kim and D. H. Woo. "Optical-Amplifier-Based Devices and Their Applications". J. of the Korean Physical Society **45**, pp. 1158-1161, 2004. PDF: <http://optiwave.com/wp-content/uploads/2014/10/xor-based-soa.pdf>.

## 10.0 ACKNOWLEDGMENTS

*Outside System Connectivity*—RF & AMS- Hiroaki Ammo, James Bateman, Herbert Bennett, Pascal Chevalier, Hassan Farooq, David Hameed, Anthony Immorlica, Jay John, James Li, Peter Magnee, Tatsuya Ooguro, Mark Rocchi, Michael Schroter, Sorin Voinigescu, *Photonic Interconnects*- Hiroaki Ammo, Carlos Augusto, Keren Bergman, Frederic Boeuf, Bill Bottoms, Mark Brongersma, William Chen, Patrick Coge, Jason Coder, Jennifer Dionne, Shanhui Fan, Michael Gaitan, C. Michael Garner, Dan Gorcea, Andrew B. Kahng, Ashok Kapoor, Lionel Kimerling, Ashok Krishnamoorthy, David A.B. Miller III, Dick Otte, Chuck Richardson, Bernard Sautreuil, Jelena Vuckovic